

Product Manual

TC57A01KNX	DIN Module Universal Fan-coil Controller 0-10V
------------	--

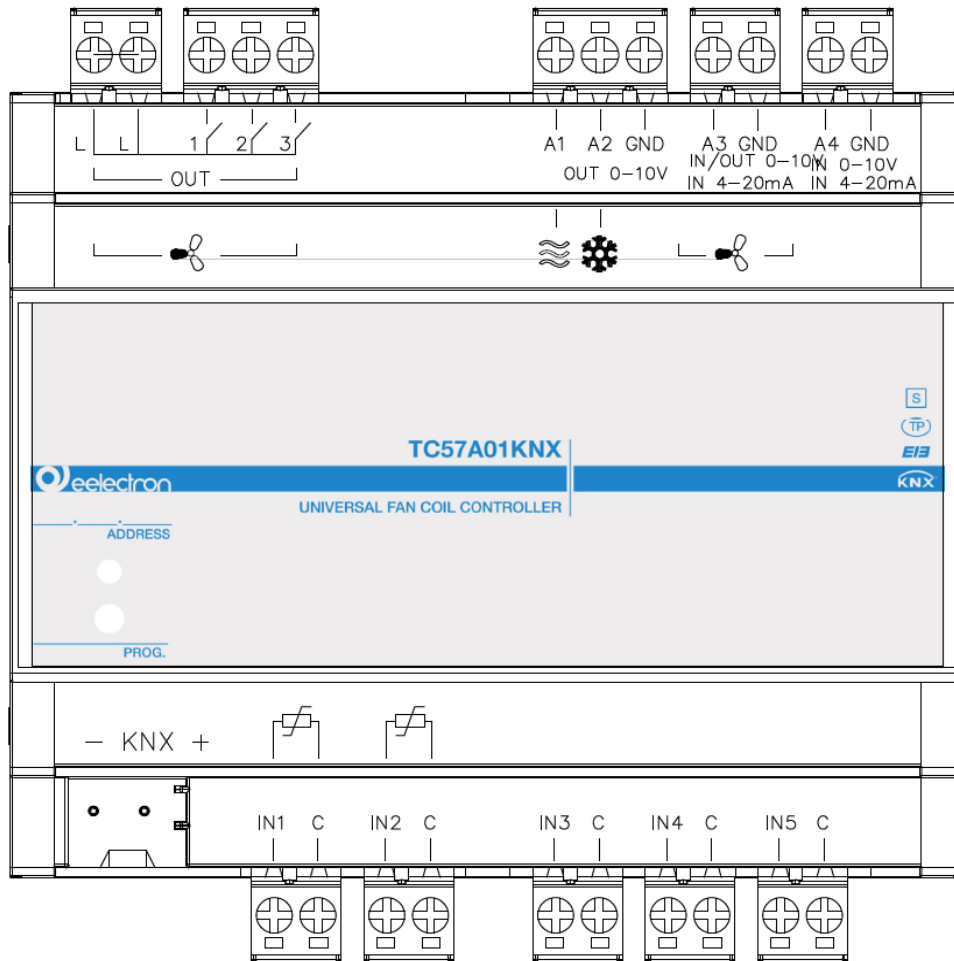

Document Version: **2**

Date: 31/03/2021

INDEX

1. Introduction	5
2. Product overview.....	5
3. Installation warnings.....	6
4. General Parameters.....	7
5. Fan coil management.....	8
Fan coil – general parameters	8
6. Thermostat.....	9
Setpoint Settings	9
COMFORT, STANDBY, ECONOMY setpoint	10
COMFORT object	11
Object ENABLE HEATING/COOLING.....	11
7. Object LOCK HEAT/COOL.....	12
THERMOSTAT OFF Object.....	12
SETPOINT ADJUSTMENT Object.....	12
ACTUAL SETPOINT Object.....	12
Two-points on/off control.....	12
Integral proportional control PWM	13
Integral proportional control continuous	13
Fan Coil - ON/OFF Control	13
Independent speed valve management	14
PI Fan coil control	15
Additional valve.....	15
Additional 6-way valve.....	16
Fan coil speed forcing.....	16
ON/OFF Ventilation Object	17
2nd Stage Object.....	17
Temperature probe – errors /measurements out of range	17
Temperature Alarm Object.....	17
8. Thermostat behaviour on power failure, reset and download	18
Behaviour on voltage drop.....	18
Behaviour on voltage recovery.....	18
Behaviour upon ETS download.....	18
Incorrect application download	18
9. Management of inputs.....	18
10. Digital input.....	19
Object enable / disable	19
Activation on closing contact.....	19
Activation on closing/opening contact.....	21
Activation on short and long contact closure.....	21
Dimming	22
Shutters and Blinds	23
Scene.....	23
Commands Sequences.....	24
Command Sequences (1 bit).....	24
Set RGB colour.....	25
MUR/DND	25
Values in loop.....	26
11. Analog input for NTC.....	26
12. Additional probe	27
Additional probe – description.....	28
Additional probe – parameters	28
Temperature Sensor	29
Probe KNX	29
13. Input 0-10V/0-20mA	30

14. 0-10V outputs	34
15. Management of relay outputs.....	37
Description of the functional blocks	37
Blocks K – 1 relay	38
Single relay – General parameters	38
Single relay – timing on/off	38
Single relay – continuous switching	40
Single relay – scene	40
Relay single – dynamic scene.....	41
Single relay – additional functions	42
<i>Single relay – logic function</i>	42
<i>Single relay – lock function</i>	42
Single relay - Global command object.....	43
Electric valve – general parameters	43
<i>Electric valve – lock function</i>	45
Block B – 2 relays.....	45
Shutter – general parameters.....	45
Shutter – alarms.....	46
Shutter - automatic movements	47
Shutter - scene	48
Shutter - dynamic scene	48
Shutter - lock	49
Servomotors - general parameters	49
Block C - 3 relay.....	51
16. Relay with interlock.....	51
17. Global objects.....	52
18. Logics.....	53
19. Virtual holder (automatic presence function)	53

Any information contained in this manual can be changed without notice.

This manual can be freely downloaded from the website: www.eelectron.com

Exclusion of responsibility:

Although the correctness of the data contained within this document has been verified, it is not possible to exclude the presence of errors or typos; Eelectron, therefore, assumes no responsibility in this regard. Any corrections required will be included in updates of this manual.

The following symbols will be used in the manual:



Symbol for relevant information



Important warning symbol



DISPOSAL: the crossed-out bin symbol indicates that the product at the end of its useful life must be collected separately from other waste. At the end of use, the user must undertake to deliver the product to a suitable separate collection centre or to return it to the retailer when purchasing a new product. Adequate separate collection for subsequent start-up of the discarded equipment for recycling helps to avoid possible negative effects on the environment and on health and promotes the reuse and/or recycling of the materials of which the equipment is made.

1. Introduction

This manual is intended for use by KNX® installers and describes the functions and parameters of the DIN TC57A01KNX module, also explaining how to change the settings and configurations through the ETS software tool.

The TC57A01KNX devices are DIN rail EIB/KNX Fan-coil Controllers equipped with 3 relay outputs of 16A-230V AC in switch mode with common L (phase) input for the direct control of motors up to three speeds, two outputs 0÷10V for the control of solenoid valves and a 0÷10V output for the analog control of motors switchable as input 0÷10V/0÷20mA. They also have a 0÷10V/0÷20mA analog input, three inputs for clean contact (without potential) plus two further promiscuous inputs for clean contact or NTC thermistor, the latter usable in the autonomous control mode of the Fan-coil.

2. Product overview

The Module TC57A01KNX is designed for use in domestic installations and civil buildings (offices, hotels, etc.) and can work both as a Fan-coil control peripheral enslaved to commands arriving from the bus, and as a local autonomous manager by implementing the thermostat function.

Main output configurations

The outputs 0÷10V (A1, A2, A3) can be configured as:

- 2 valve control channels (A1, A2);
- one channel for speed control (A3), switchable as 0÷10V / 0÷20mA input.

The relay outputs (OUT 1, 2, 3) (relay K1, K2, K3) can be configured as:

- single direct command output for 3-speed motors;
- output for commands of two-speed motors plus an independent output;
- single speed motor control output plus 2 independent outputs.

It is also possible to combine 2 or 3 relays by creating a **logic interlock** (i.e. the management of several relays with a single command).

Main input configurations

The module inputs are divided into three categories:

- clean contact inputs (IN1, IN2, IN3, IN4, IN5);
- 0÷10V / 0÷20mA inputs (A3 - IN/OUT switchable by software as 0÷10V output- and A4).

The inputs IN1 ÷ IN5 can be connected to buttons, switches and in general to clean contacts (for example relay outputs of other modules). IN1 and IN2 can be configured by software as analog for the reading of NTC thermistors combined with the thermostat function or to send on the bus temperature measurements and manage a simple on/off control (for example in the case of radiators).

The inputs can be configured for:

- 1-bit commands: load activation/deactivation commands (ON/OFF/TOGGLE) from external button with short press or with differentiation of long and short press;
- 1 byte commands (0-255 or HVAC commands or % value commands);
- the sending of long action related telegrams on the same short action address or on a different group address;
- cyclic sending commands;
- sequences (3 mixed object commands 1 bit/1 byte) with different group addresses - in short and long press mode or in toggle mode;
- Dimmer management (with single button or double button);
- roller shutter management (with single button or double button);
- command sequences with 1 bit to manage the switching on/off of lights or rows of lights;
- RGB colour setting at fixed value (short press) or colour change (long press); selectable 1 byte or 3 byte datapoint;
- MUR/DND (Make Up Room/Do Not Disturb), function with built-in logics;
- Loop function between values to send a sequence of 1 byte values step by step.

It is also possible to enable 2 complete thermostat modules, each of which manages 2 stages with integrated PI controller for the control of heating and cooling equipment, valves, 2 and 4-pipe fan coils, etc.

NTC probes

The following accessories with Eelectron code must be used for the NTC temperature probe:



TS01A01ACC (from -20°C to +100°C)
 TS01B01ACC (from -50°C to +60°C)

Main temperature sensor configurations

By configuring inputs IN1 and IN2 as temperature sensors it is possible to implement these main functions:

- 2 different temperature thresholds to activate alarms/warnings by sending 1 bit telegrams on the bus;
- Enabling/disabling of alarms/warnings via 1-bit objects.

By configuring IN1 and IN2 as thermostats (2 thermostats) the following main functions are obtained:

- different Control algorithms: 2-point on/off; PWM; continuous control/Fan Coil control;
- different operating mode setting modes: Automatic HVAC/Manual HVAC/Setpoint;
- window contact management to turn off the fan-coil if the windows are open and to economise on operation;
- additional external probe (optional).

standards and directives of the country in which the products will be used. The KNX bus allows remote commands to be sent to the system actuators. Always check that the execution of remote commands does not create dangerous situations and that the user is always notified of which commands can be activated remotely.

- The relays of the device, leaving the factory, are configured as open; the contacts may close during transportation even if the device is not powered. It is advisable, upon the first power-up, to first connect the bus in order to ensure opening of the relays and only then the voltage to the loads.
- The device must be installed in low voltage distribution panels ensuring the IP20 degree of protection by means of the dedicated covers supplied with the electrical panels.

For information visit the website
www.eelectron.com

3. Installation warnings

The device can be used for permanent indoor installations in dry places and is intended for mounting on DIN bar in LV distribution switchboards.



ATTENTION

- The device must be installed maintaining a minimum distance of 4 mm between the non SELV voltage lines (>50V DC or > 25 VAC) and the cables connected to the EIB/KNX bus and to the inputs.
- The device must not be connected to live cables and never to a 230V line.
- The appliance must be installed and commissioned by a qualified installer.
- The regulations in force concerning safety and accident prevention must be observed.
- The device must not be opened. Any defective devices must be sent to the competent office.
- The design of the systems and the commissioning of the equipment must always comply with the mandatory

4. General Parameters

The setting of the device using the ETS software tool will be described below, with the premise that the choice of one or more options will make the related functions and options available, changing the appearance of the panel and the menu items.

Delayed transmission upon switch on

Settable value: 3 ÷ 15 seconds

With this parameter it is possible to set a delay on the transmission of telegrams following switching on or reset of the device, selecting the time beyond which the device can send telegrams.

In systems with a large number of devices, this delay makes it possible to avoid a situation whereby, in the event of a power failure or shutdown, upon restart, all the devices simultaneously engage the bus, generating excessive data traffic on the bus and causing a reduction in communication performance on the system.

If there are many devices that require the sending of telegrams after switching on, this delay must be programmed in order to minimise traffic peaks.

The detection of inputs and the value of the communication objects are updated in accordance with the expiry of the transmission delay. At the end of programming with ETS, the device behaves as it does when switching on, applying the delay (if set).

Use device as fancoil with internal links

Settable value: Yes – No

Through this parameter it is possible to configure the module both as a controller incorporated in the Fan-Coil, and as an actuator of external commands.

By setting **Yes**, the settings panel corresponding to the Fan-coil Controller mode appears in ETS, which are the following.

- **Number of pipes:** by setting **2**, the analog output 2 (A2) becomes available because the control of a single solenoid valve is supported through the A1 output; by setting **4**, A1 and A2 will be used to control the 2 solenoid valves of the hot and cold circuits. Solenoid valves can also be managed by relays not used for speeds.
- **Speed type:** by setting **bit**, the fan-coil motor will be piloted through the

exchanges of relays K1, K2, K3, based on the speeds selected from the Speed number drop-down menu; by setting **proportional** the fan-coil motor will be driven by output A3 (0-10V signal); the relays can then be used independently and **Relay outputs** appears instead of **Speed number**. The following table summarises the settings.

Bit (Speed number)		
1 speed	2 speed	3 speed
K2 and K3 available and settable as single relay or solenoid valve command	K3 available and settable as single relay or solenoid valve command	K1, K2, K3 not available and used by the Fan-Coil function

Proportional (Relay outputs)		
01: 3x1 relay	02: 1x2 relay + 1x1 relay	03: 1x3 relay
K1, K2, K3 individually settable as single relay or solenoid valve control.	K3 can be individually set as single relay or solenoid valve; K1 and K2 used as diverter (block B1) that can be set as roller shutter or servomotor command or 2-output interlock.	K1, K2, K3 act as a switch of the phase line applied to the LL terminals (block C1) 3-output interlock.

- **Analog output 1 and 2:** by choosing enabled, the relative analog output is available. The outputs are not selectable by setting **Use device as fancoil with internal links** to yes.
- **Analog input/output 3:** it is used to enable this line as an input or output, or to disable it.
- **Analog input 4:** by setting enabled, the reading of the voltage or current on it is enabled; setting disabled it is ignored.
- **Input 1 type:** it is used to set whether IN1 will work as associated with a dry contact

(digital) or analog (NTC reading associated with the temperature function).

- **Input 2 type:** it is used to set whether IN2 will work as associated with a dry contact (digital) or analog (NTC reading associated with the temperature function).
- **Temperature 1 function:** the relative drop-down menu is used to enable the temperature function associated with IN1 and, more precisely, the **temperature probe** activates the reading and relative communication of the data if the module is interrogated via the KNX bus, while the **thermostat** will act in such a way that the IN1 reading will be compared with the thresholds set in the thermostat function. In both conditions, the item **Temperature 1 alarm object** will appear in the panel.
- **Temperature 2 function:** that explained for "Temperature 1 function" applies.
- **Use virtual holder** it is used, by clicking on the enabled option button, to activate the presence detection function, used to subject the operation to the possible presence of persons detected by the dedicated sensor (for example to limit use of the Fan-coil in the absence of persons in the room where it is installed).

5. Fan coil management

The TC57A01KNX was created for the management of Fancoils and therefore natively supports the direct connection to the Fancoil as well as the acquisition of the parameters that determine its activity, or external commands.

Regarding the actuations, the following configurations support various modes that combine the use of the individual relay outputs (K1, K2, K3) of block B and block C, but also of the analog outputs intended for proportional control of the electro-fan and solenoid valves.

Fan coil – general parameters

On the ETS General Parameters page, with the option **Use device as fancoil with internal links** it is established whether the TC57A01KNX will work as a local fan-coil manager or not; by clicking on the Yes option, the page changes and the items **Number of**

pipes (referring to the management of the solenoid valves), **Speed type** and **Number of speeds** appear. The item **Temperature 1 Function** appears in the menu, which will be assigned to the Fan-coil management and at the same time this ETS parameter will no longer be available on the General Parameters page. The ETS Relay Outputs and Analog Outputs pages will change according to the choices made, as shown in the following table.

KNX PARAMETER	SETTINGS
Number of pipes	2 pipes
	4 pipes
<p>It defines whether the device will control one or two valves, i.e. if it will cut off only one fluid (hot/cold) by operating the heating only or cooling only mode, or hot/cold vector fluids to operate the heating/cooling mode. The control will be proportional.</p> <p>2 pipes</p> <p>Analog output A1 is used for the management of the hot/cold valve; A2 is free for uses not related to the management of the fan-coil</p> <p>4 pipes</p> <p>The analog output A1 is used for the management of the hot valve; A2 for the cold valve.</p>	
Speed type	bit
	proportional
<p>This parameter establishes whether the electric fan will be controlled by the relay outputs or by the analog output, which in this case will be A3.</p> <p>bit</p> <p>The control of the electric fan is entrusted to the relays, according to the speed scheme set in Number of speeds. If the electro-fan has a number of speeds lower than 3, the K2 (and K3) relays will be available on the page, while K1 will always be responsible for controlling the electric fan.</p> <p>proportional</p> <p>The control of the electric fan switches to analog then Analog Input/Output 3 disappears from the page and for this purpose, is set as output. The page also makes available the K1, K2 and K3 relays because they are not linked to the motor control and the Number of speeds menu becomes Relay outputs.</p>	

The possible and obtainable configurations for the outputs by selecting **Use device as fancoil with internal links** are summarised in the following two tables.

Valves		
Output type	A1	A2
2 pipes	Hot/cold	-
4 pipes	Hot	Cold

Speed				
Output type	K1	K2	K3	A3
Bit 3 speed	Speed 1	Speed 2	Speed 3	-
Bit 2 speed	Speed 1	Speed 2	-	-
Bit 1 speed	Speed 1	-	-	-
proportion al	-	-	-	Variable speed

The versatility of the device is evident, which is used to combine various modes to free a number of outputs.

6. Thermostat

The temperature function can be configured as a thermostat to control the temperature of a room or area by activating the heating or air conditioning, the fan coils, the air conditioning valves or via the on/off controls for the heating/cooling elements such as radiators, heat pumps, split, etc.

 The thermostat works at temperatures between -9.9 and + 99.9°C with a resolution of 0.1°C.

The setpoint values (including the SETPOINT MODE) from the bus are accepted in the range from 10°C to 50°C.

The thermostat function is active when the device is configured for the fan-coil application: with the

parameter **Use device as fancoil with internal links** set to Yes but can also be activated without setting this choice. In this second case the ETS Thermostat module is free and it will be the programmer's responsibility to connect the objects of this module with the output modules, even if these are on board the device itself.

The following treatment does not change in both cases as the thermostat module is identical in both options, but programming is facilitated if the thermostat module uses the outputs on the TC57A01KNX.

If the parameter **Use device as fancoil with internal links** is set to **No**, choosing the mode **Thermostat** from the drop-down menu in "General parameters > Temperature 1 function", the items relating to the same number of ETS pages for setting of the thermostat function are made available in the left menu under the item "Reference temperature 1" which is the following:

- Thermostat Settings;

In addition is the fact that others depend on the settings made by opening the ETS page **Thermostat Settings**, in which it is possible to access the general configuration of the thermostat function. To be precise, the additional items depend on the first setting found on this page, that is **Use thermostat to control fan coils**: by clicking on the "no" option button, the thermostat will be used to generate telegrams on the bus when the set thresholds are exceeded or when the temperature falls below them, according to the settings that can be made from the page itself and from other related ones; clicking on "yes" the thermostat will show the typical options of a fan-coil controller, leaving the programmer the freedom to connect the addresses even between communication objects of the device itself. Other parameters like **Thermostat control mode** activate specific pages to set the behaviour.

Setpoint Settings

The control setpoint can be changed from the bus in two different ways, using one of these objects:

HVAC Mode (manual or automatic) SETPOINT Mode

The choice depends on the device that works as the master: a timer-thermostat, a control panel or a SW

supervisor. Listed here is the list of objects to change the active mode or setpoint value via bus.

SETPOINT Object

When the "Thermostat control mode" parameter is selected with the SETPOINT value, the HVAC mode of the object is no longer visible. Each time the thermostat receives a value on the SETPOINT object (size 2 bytes), it is used as a setpoint for temperature control.

HVAC Object (manual)

Using the HVAC MODE object (1 byte size), it is possible to set the thermostat in one of the following modes: OFF; ECONOMY; STANDBY; COMFORT; each mode is associated with a setpoint set by an ETS parameter. The OFF mode is associated with the antifreeze set point in heating mode and the high temperature protection set point in cooling mode.

HVAC Object (automatic)

For this value of the "Thermostat control mode" parameter, the behaviour is the same as that described above but the changeover from heating to cooling mode (and vice-versa) is automatic. With this setting it is necessary to create an intermediate zone between heating and cooling whose amplitude is defined as "Dead band".

Whenever the temperature becomes greater than: **Heating comfort setpoint + (Dead band/2)** cooling control is active; when the temperature is lower than **Cooling comfort setpoint - (Dead band/2)** the heating control is active.

The following image clarifies the concept. It is possible to set the comfort setpoint as the centre of the dead band through the relative parameter; the comfort value is common to the heating and cooling modes.

KNX PARAMETER	SETTINGS
Comfort setpoint	setpoint H/C
	dead band center

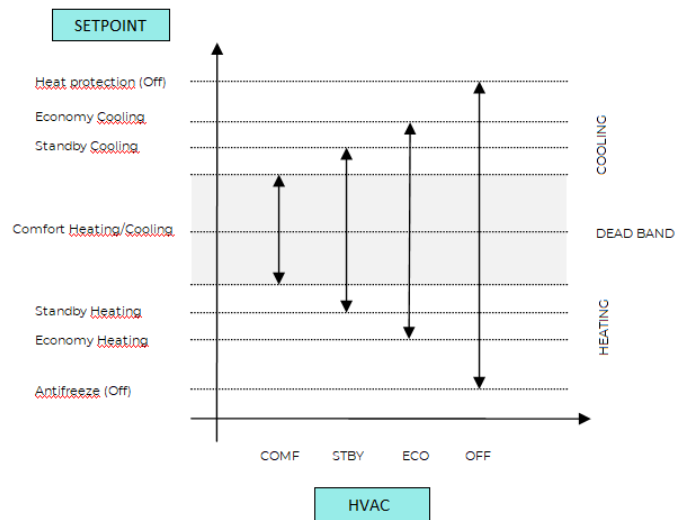

COMFORT, STANDBY, ECONOMY setpoint

These 2-byte objects are used to set the setpoint values for the COMFORT, STANDBY and ECONOMY mode.

At each variation, the setpoint is saved in memory. After downloading these setpoints are reset to the values defined by the ETS parameter; when turned on, these objects are returned to the last value before they were turned off.

Use these communication objects to change the current setpoint for each HVAC mode based on the currently active control (heating or cooling).

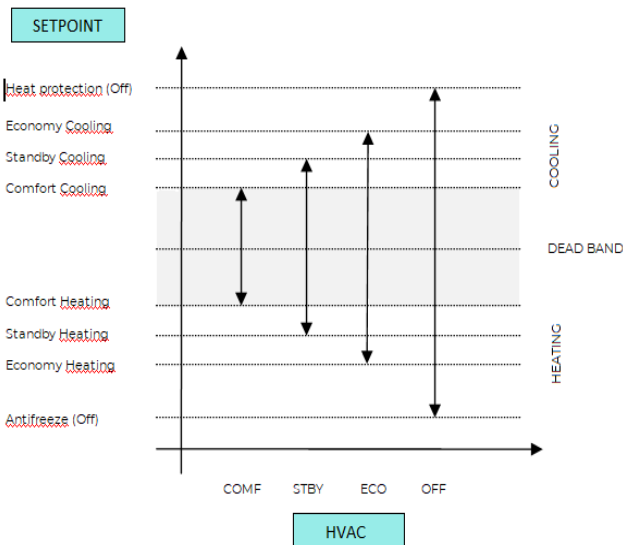

KNX PARAMETER	SETTINGS
Action to execute for setpoint	modify relative modify absolute
Setting this parameter on "modify relative", the thermostat will take into consideration the new set value but will still consider the set point set in ETS as a reference to determine the permitted variation range ($\pm 1, \pm 2, \pm 3, \dots$); instead by choosing the "modify absolute" value, this interval will also be recalculated.	

...
 The following table further explains the meaning of the settings for "Action to be performed for the setpoint".

Action to execute for setpoint	
Modify relative	
Objects Setpoint 2 byte for mode	Object Setpoint 2 byte for adjustment
Upon receipt of a new setpoint on this object, the user adjustment is recalculated, always taking into account the limits set in the thermostat. If set in transmission, these objects send their current value upon their state change.	In this object it is possible to find the current value of the user adjustment set inside the thermostat. In order to reset the user forcing, simply send 0 on that object. If set in transmission, the object will notify any relative user variation on the bus.
Modify absolute	
Objects Setpoint 2 byte for mode	Object Setpoint 2 byte for adjustment
Upon receipt of a new setpoint on this object, the thermostat considers it as the new base setpoint (this means that the temperature limits that can be set in the thermostat are recalculated), also resetting the user variation.	In this mode, the User Adjustment object is used to send the thermostat a new current setpoint (written in absolute mode) of the current mode, always taking into account the limits set in the thermostat via the permitted regulation parameter. In transmission, this object will not send anything on the bus.

COMFORT object

The COMFORT object (1 bit size) is only visible when the "Thermostat control mode" parameter is selected with the HVAC MODE value. When a telegram "1" is received, the thermostat switches to COMFORT mode (valid for both heating and cooling).

Upon receipt of a "0" telegram, the thermostat returns to the mode set by the HVAC MODE object. The COMFORT mode can also be set in timed mode. After a time set by a parameter, the thermostat returns to the selected mode.

KNX PARAMETER	SETTINGS
Comfort object timing	time unlimited time limited
Comfort overwrite time [min]	1..255

Object ENABLE HEATING/COOLING

This object is only present in automatic mode. If enabled, it is used to enable or disable the heating or cooling mode.

KNX PARAMETER	SETTINGS
Enable object	cool. / heat.
It is used to select which mode can be enabled/disabled	
State after download	disabled/enabled
It establishes whether after a download the mode selected in the previous parameter is enabled or disabled.	
Activation telegram	telegram "0" / "1"
Telegram to enable the mode.	

7. Object LOCK HEAT/COOL

This object is only present in automatic mode. If enabled, it is used to block the heating or cooling mode in the current state.

Lock telegram	telegram "0"/"1"
Telegram to lock the mode.	

Object WINDOW CONTACT

This object, if enabled, has a higher priority than HVAC MODE, SETPOINT MODE, COMFORT. When a telegram ("0" or "1") is received on the "Window Contact" communication object, the thermostat enters an energy saving mode: PROTECTION mode (if running in HVAC MODE) or SETPOINT anti-frost/high temperature protection (if running in SETPOINT MODE).

If the received telegram indicates that the window is open, the thermostat changes mode or setpoint 1 minute after receiving the telegram.

When it receives a telegram corresponding to the "window closed" state, it restores the previous mode, again with a 1 minute delay. The SETPOINT VARIATION value (if activated) is always reset.

THERMOSTAT OFF Object

The Thermostat OFF object is used to stop the Temperature Controller from the Bus with a 1-bit telegram.

SETPOINT ADJUSTMENT Object

The SETPOINT ADJUSTMENT object is used to temporarily change the setpoint value used by the thermostat, applying an offset to the current value. If the thermostat works in HVAC MODE, the offset value is applied from the moment a valid telegram is received on the SETPOINT REGULATION object until this value changes, even in the event of a change in the active mode (Comfort and Standby). When the device enters Economy mode, this value can be reset or not based on the "Reset SP adjustmen on HVAC economy" parameter. Entering the PROTECTION mode the value of the SETPOINT CHANGE object is forced to 0.

Similarly, if the thermostat is operating in SETPOINT MODE the offset value is also applied when the setpoint value received on this object changes.

ACTUAL SETPOINT Object

The ACTUAL SETPOINT object sends the setpoint in use and is sent each time:

- the HVAC mode object changes;
- the SETPOINT object changes;
- the SETPOINT CHANGE object changes;
- after a download;
- one minute after power on.

Two-points on/off control

The "2 points on/off" control algorithm is used to control the heating or cooling elements by turning on and off the same elements such as radiators, underfloor heating with shut-off valves, boilers, etc. When the thermostat switches to "winter mode" (heating), it sends a shutdown command to the COOLING ON/OFF object and activates the control only via the HEATING ON/OFF object (the COOLING ON/OFF object is therefore no longer updated until it returns to "cooling mode"). Therefore, in the transition from "winter" to "summer" mode, it sends a shutdown command on the HEATING ON/OFF commands and activates the control through the COOLING ON/OFF object.

The following image shows the conceptual scheme of the on/off control in heating.

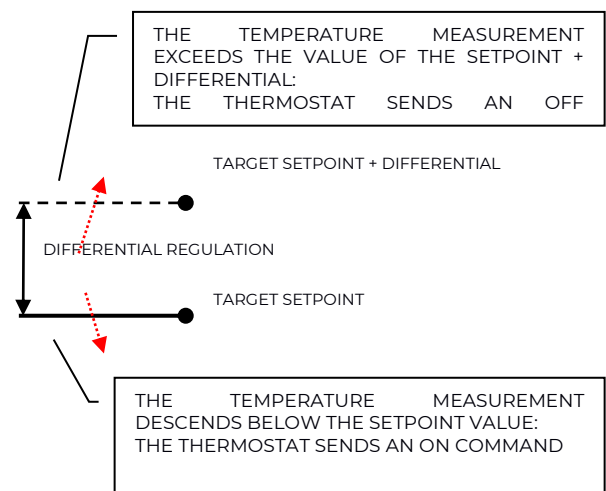

The following image instead shows the operation of the on/off control in cooling.

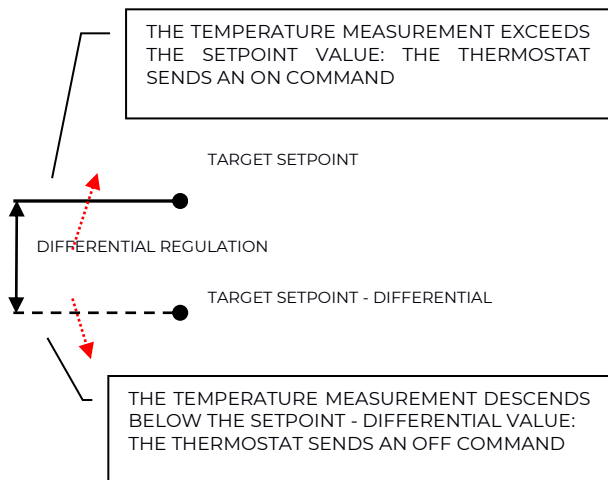

Integral proportional control PWM

The integral proportional control with PWM is an algorithm that reduces the effects of the hysteresis around the setpoint value by adjusting the control in values between 0% and 100% where 0% means "off – no action" and 100% means "maximum control action".

Once a cycle time has been defined, the thermostat sets the actuator to ON for a fraction of the cycle time and OFF for the remaining part. Piloting the actuator with a control value of 80% means making it active (i.e. ON) for 80% of the cycle time and OFF for the remaining 20%.

KNX PARAMETER	SETTINGS
Cycle time	10, 20, 30, 60 min
It defines the time interval on which to implement the proportional control	
Control type	proportional integral
It defines which control to use. If proportional, no integration time is considered. If integral, parameter "Heating system" or "Cooling system" suggests common values for setting "Proportional band [Bp]" and "Integration time [min] [Ti]" parameters. Use "advanced setting" to manually set values.	
Proportional band [Bp]	1, 2, 3, 4, 5 °C

The proportional band Bp is a temperature interval between "Setpoint" and "Setpoint-Bp" in heating mode and between "Setpoint" and "Setpoint + Bp" in cooling mode. Within this interval the thermostat controls the temperature using the 'proportional algorithm'; outside this band, the actuator is always commanded to ON or OFF.	
When the temperature is within this range, it will wait for the cycle time to finish before calculating the ON and OFF time of the next cycle. When the temperature is outside this range, i.e. below "Setpoint-Bp" in heating mode or above "Setpoint + Bp" in cooling mode, a new cycle starts as soon as the temperature returns to BP.	
Integration time [min] [Ti]	5 .. 250 min
It defines the duration of the integration time	

Integral proportional control continuous

This control mode is very similar to "Integral proportional control PWM" in terms of algorithm and parameters, but it uses a 1 byte object (% value) to send the command on the bus which will no longer determine the duty-cycle (period duration/time ON) but a control signal for solenoid valves type 0 - 10V.

Fan Coil - ON/OFF Control

The Fan Coil is a heating/cooling device based on the emission of air pushed by a fan through a heat exchanger in which a fluid, respectively cooling or heating, circulates; the flow of the fluid is controlled by a solenoid valve (2-pipe model) if there is only one circuit for the fluid used in heating or cooling or two valves (4-pipe model) if the equipment can manage two distinct and independent circuits.

In cooling, the fluid absorbs heat from the ambient air brought to the exchanger by the fan, while in heating it transfers heat.

The electric fan is driven by an electric motor which is generally in alternating current and has 3 windings, each of which corresponds to a speed.

The control logic for a 3-speed Fan-coil in heating mode is shown below.

When the temperature rises, the following scheme applies:

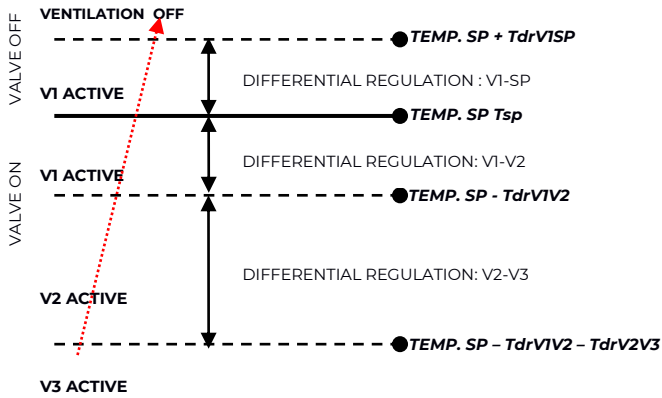

When, instead, the temperature decreases, what is shown in the following image takes place.

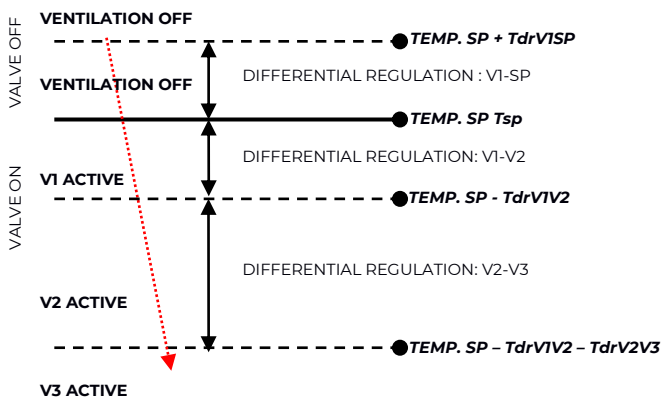

Where:

- T_{sp} = Setpoint temperature;
- T_{drV1SP} = HEAT. regulation differential for V1-SP;
- T_{drV1V2} = HEAT. regulation differential for V1-V2;
- T_{drV2V3} = HEAT. regulation differential for V2-V3.

The control logic for 3-speed Fan-coil in cooling is schematised below.

When the temperature decreases, the following scheme applies:

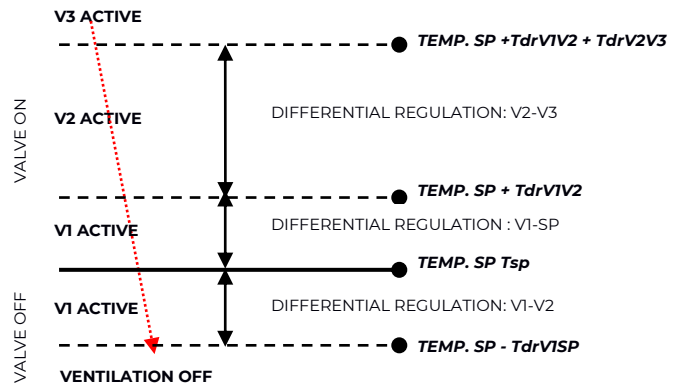

When the temperature increases

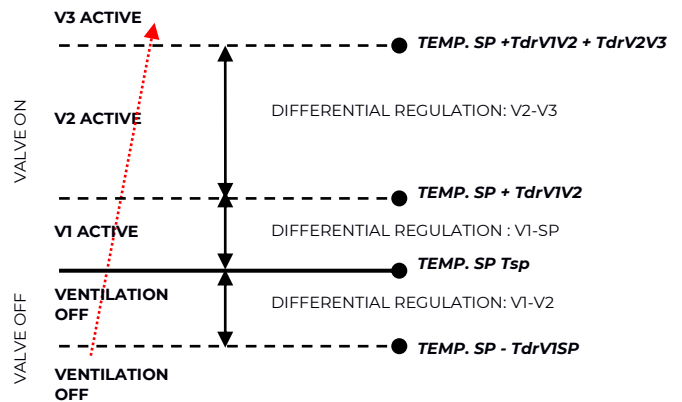

Where:

- T_{sp} = Setpoint temperature;
- T_{drV1SP} = COOL. regulation differential for V1-SP;
- T_{drV1V2} = COOL. regulation differential for V1-V2;
- T_{drV2V3} = COOL. regulation differential for V2-V3.

Independent speed valve management

In Fan-coil on/off mode it is possible to make the opening or closing of the valve independent from the switching on or off of the speeds by setting the option **yes** for the parameter **Manage valves independently**. This makes the drop-down menus from which to set the valve regulation differentials

visible on the ETS page, which will therefore be distinct from those set for the speeds. The valve can therefore be kept open even when the fans are stopped.

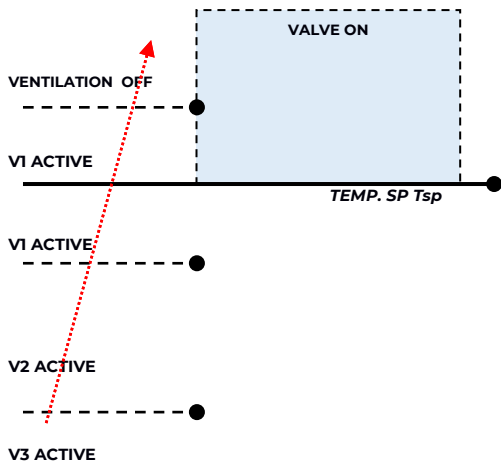

The dashed line area represents the temperature range defined by the "heating regulation differential ON" parameter in case of increasing temperature. When the temperature decreases, the "heating regulation differential ON" parameter defines the valve hysteresis.

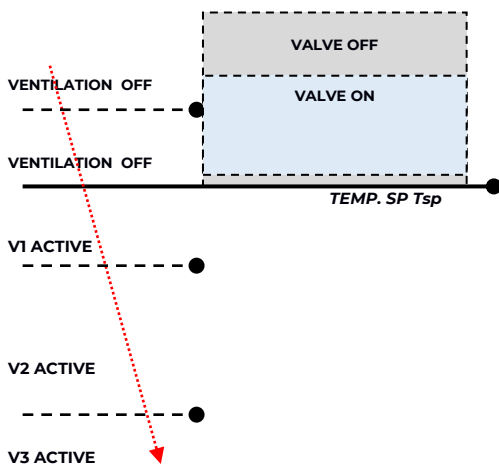

If parameter "Fancoil valve" in the "Thermostat Settings" page is set to "proportional", valves are set as independent and parameters "bandgap" and "proportional band [Bp]" can be set specifically for both cool and heat status.

PI Fan coil control

The logic and parameters are the same used in On/off with the PWM control mode; the difference is that now the proportional value is sent to the bus via a 1 byte format object as a % value from 0% to 100%.

This mode is useful for controlling Fan coils (selecting 2 or 4 pipes) or generic proportional actuators such as valve drivers; in this case, only the 1-byte object must be connected, avoiding connecting the valve objects.

Additional valve

In fan coil mode it is possible, in 4-pipe systems, to enable an additional valve object. This object is used when the thermostat has to manage 2 different systems, one in heating and one in cooling.

Imagine having a floor system in heating mode and a 3-speed fan-coil system in cooling mode. To manage this system it is necessary:

- to set the parameter: "Thermostat Settings > use thermostat for fan-coil control" = yes;
- set the parameter "Fan-coil - ON/OFF control > Enable fancoil speeds on" = cooling or "Fan coil - continuous control > Enable fancoil speeds on" = cooling;
- set the parameter "Fan coil - ON/OFF control > System type" = 4 pipes or "Fan coil - continuous control > System type" = 4 pipes;
- set the parameter "Enable additional valve" = enabled;
- set the parameter "Additional valve > Enable valve with" = heating;
- set the parameter "Additional valve > Control algorithm" = as required by the system conditions.

Additional 6-way valve

The additional valve also manages controls for 6-way valves in which the control value from 0% to 100% defines both the valve opening percentage and the passage of hot or cold fluid, as shown in the following image.

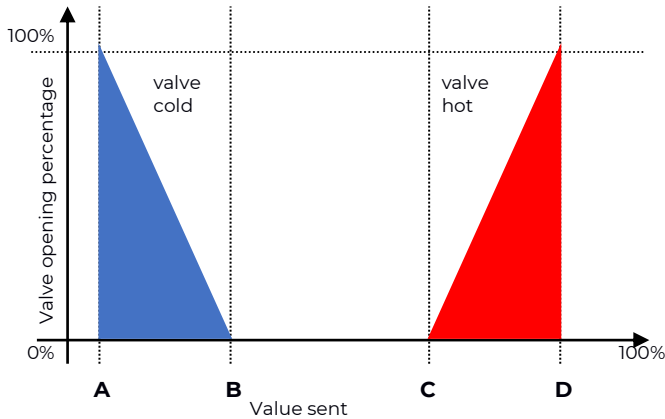

KNX PARAMETER	SETTINGS
Percentage 100% cool	0% ÷ 30%
Value to bring the cold valve to the 100% open position [point A of the graph]	
Percentage 0% cool	23% ÷ 53%
Value to bring the cold valve to the closed position (0% open) [point B of the graph]	
Percentage 0% heat	47% ÷ 77%
Value to bring the hot valve to the closed position (0% open) [point C of the graph]	
Percentage 100% heat	70% ÷ 100%
Value to bring the hot valve to the 100% open position [point D of the graph]	
Value to send for valve fully closed	36% ÷ 66%
Value to bring both the cold and hot valves to the completely closed position (point of the graph between B and C).	

For the additional valve, in 6-way mode it is possible to define distinct regulation differentials around the setpoint value, as shown in the following image.

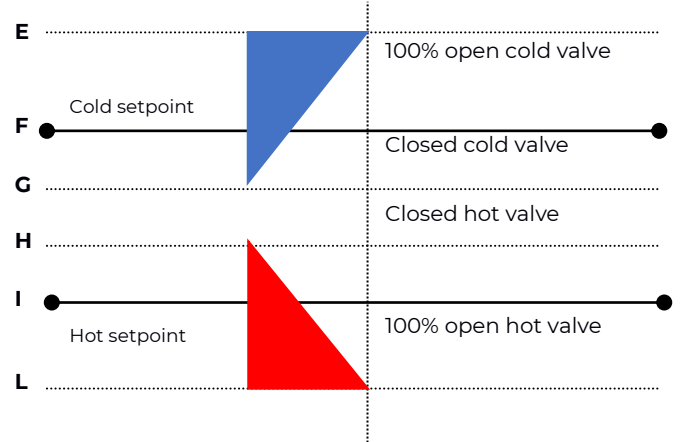

This is used to adjust the opening and closing of the additional valve independently of the speed regulation (for example, once the setpoint has been exceeded, it is possible to perform a maintenance action while still holding the valve open without activating the speeds).

KNX PARAMETER	SETTINGS
Regulation differential valve 0%	0°C ÷ 5°C
It defines the width of the F-G bands for cold and H-I for heat.	
Regulation differential valve 100%	0°C ÷ 5°C
It defines the width of the E-F bands for cold and I-L for heat.	

Fan coil speed forcing

In Fan coil mode (1-bit or 1-byte management), it is possible to force the use of a single speed and to bypass automatic selection of the same. This mode is useful, for example, in small rooms such as hotel rooms, or where the fan speed can cause noise. To activate the forcing, it is necessary to act on the 1-bit object that selects AUTO/MAN and then on the object that activates the desired speed (3x 1-bit object or 1x 1-byte object in % mode).

ON/OFF Ventilation Object

When using the fan-coil, it is also possible to activate the "ventilation" mode. In this mode, the fan-coil never turns off the fan even when, after reaching the desired setpoint, the heating/cooling valve closes. In any case, it is necessary to set the desired speed for ventilation using the speed forcing object; in AUTO mode, in fact, the ventilation will stop when the set point is reached. It is also possible to make the "ventilation" mode already active after the download without having to switch it on/off via a communication object.

2nd Stage Object

The 2nd Stage object is an additional control object for the regulation of a second heating or cooling appliance. It is possible to set a 1-bit or 1-byte control for this object; where the control is of the 1-byte type, it is possible to set the PI control (Proportional Integral). The "Bandgap" parameter is used to set how much the current setpoint is translated to manage the switch-on and switch-off point of the equipment driven by the 2nd stage object. For example, if the setpoint in heating is 20°C and "Bandgap" is set = 1 then the setpoint for only the part driven by the 2nd stage object will be 20-1= 19°C; conversely if "Band" is = -1 then the 2nd stage setpoint will be 20 - (-1) = 20+1 =21°C. For 1-byte object is it possible to set control as "proportional" or "integral", managing parameters like "Proportional band [Bp]" and "Integration time [min] [Ti]" (if integral).

 If the equipment to be controlled as 2nd Stage is a 1,2 or 3 speed Fan-coil, it is advisable to set the 2nd stage as 1-Byte and to send the ignition value % in the logic called "proportional/speed fan-coil conversion" to obtain 1-bit output objects available for the 3 speeds.

Temperature probe – errors /measurements out of range



If the temperature probe is disconnected or short-circuited, the control action is interrupted and the controlled actuators are deactivated.



The value of the temperature sent on the bus in case of disconnection or short circuit of the

probe or for a measured value out of range is 0°C (according to the standard KNX DPT_Value_Temp 9.001).

Temperature Alarm Object

Alarm objects are available for each thermostat and for each temperature probe; in case of probe failure or out of range measurement, a telegram with value "1" on the 1 bit communication object is sent on the bus. As soon as the temperature sensor works again, the value "0" is transmitted.

To correctly manage the internal or rear probe or KNX via bus, refer to the following configuration modes:

CONFIGURATION 1 MODE
Only probe connected to input 2
If the temperature probe is disconnected or short-circuited, the control action is stopped and the controlled actuators are deactivated.
Probe disconnection/short circuit/measurement out of range: <ul style="list-style-type: none"> • "Temperature" obj is not sent • "Alarm" obj transmits "1"

CONFIGURATION 2 MODE
Only KNX probe temperature
The KNX probe is read considering the last value received on the "KNX probe temperature" Obj.
If the KNX probe value is out of range or the surveillance time expires without any message received: "Alarm" Obj transmits "1" until the KNX probe is received again.

CONFIGURATION 3 MODE
Mix of probe connected to KNX probe input and temperature
The KNX probe is read considering the last value received on the "KNX temperature probe" Obj.
The value of the temperature sent on the bus is the weighted average between the values of the front probe and KNX probe.
If the KNX probe value is out of range or the surveillance time expires without having received any message, the thermostat starts considering only the other probe until

it receives a new valid value from the KNX probe; in this case the bus value is considered again.

8. Thermostat behaviour on power failure, reset and download

Behaviour on voltage drop

In case of bus voltage failure, no action is performed by the device; the behaviour of the controlled actuators must be set using the parameters of the actuators themselves.

Behaviour on voltage recovery

When the bus voltage is restored, all communication objects are set to "0" except those for which a parameter is defined for the initial value; the thermostat keeps these values in memory and retrieves them when the voltage is restored:

- Heat / Cool mode
- HVAC Mode
- Base Setpoint
- Setpoint Adjustment
- Force value in manual mode
- Ventilation

Control values (i.e. commands for actuators) are calculated using the actual setpoint and temperature.



After switching on, the device recalculates the commands to the actuators and turns them on, if necessary, otherwise it does not perform any action; it is advisable to set the actuator behaviour to shut down the heating/cooling equipment after bus reset.

Behaviour upon ETS download

After the download it is possible to set the initial value of:

- Heat / Cool mode
- HVAC Mode
- Ventilation

For other communication objects, the behaviour is identical to bus voltage recovery.

Incorrect application download

If an incorrect ETS application is downloaded, the KNX/EIB LED starts flashing and the device does not become operational on the bus. It is necessary to reset the device by removing and applying the power again, then to download the correct ETS application.

9. Management of inputs

The module has 5 inputs set as digital input for clean contacts (voltage free): two of them can work as analog for the reading of temperature probes. There is also an analog voltage or current input (A4) and a mixed one (A3) that can be set as analog input/analog output.

The following table describes the available functions.

	FUNCTION
IN1	DIGITAL INPUT / TEMPERATURE PROBE
IN2	DIGITAL INPUT / TEMPERATURE PROBE
IN3	DIGITAL INPUT
IN4	DIGITAL INPUT
IN5	DIGITAL INPUT
A3	ANALOG INPUT 0-10V or 0-20 mA/ANALOG OUTPUT 0-10V
A4	ANALOG INPUT 0-10V or 0-20 mA

The two temperature functions and the complete thermostat modules are associated with the inputs (one can be reserved for the Fan coil management from the inside), all according to the following diagram.

	FUNCTION
IN1	TEMPERATURE PROBE + COMPLETE THERMOSTAT/FAN COIL (Temperature 1 Function)
IN2	TEMPERATURE PROBE + COMPLETE THERMOSTAT (Temperature 2 Function)

As mentioned in the "Fan-coil management" chapter, if the option is selected on the ETS General Parameters page **Use device as fancoil with internal links**, the "Temperature 1 Function" is associated with this management and disappears from the ETS General Parameters page. But this function is not exclusive, in the sense that it can be managed individually if **Use device as fancoil with internal links** is set to "No". Instead the "Temperature 2 Function" is always independent. Thermostat 1 is always associated with the fan-coil management with internal links, while Input 1 and Input 2 are independent, therefore the Temperature 1 function, associated with Thermostat 1, can also receive the input via an object linked to an incoming telegram from another device.

10. Digital input

In **Digital input** mode each input from IN1 to IN5 can be configured to perform one of the following functions available in the drop-down menu on the corresponding page:

- no action (inactive and therefore ignored even if connected and receiving signals);
- activation on closing contact;
- activation on closing/opening contact;
- activation on short and long contact closure;
- dimming;
- shutters and blinds;
- scene;
- commands sequences (short and long contact closure);
- commands sequences (toggle);
- commands sequences (1 bit);
- set RGB colour;
- MUR/DND (make room/do not disturb);
- Loop among values (1 Byte).

The setting is performed separately for each input from the page **ETS Digital Inputs**, by clicking on the corresponding name. Remember that where in General Parameters, Input Type 1 is "analog" in the menu Input 1 will become Additional probe 1; it is the same for Input Type 2.

Each mode has a specific ETS page, as described below.

All the functions that can be associated with the inputs are subject to the enable/disable parameter (and to the object), therefore they are valid if the parameter is "enable" (enabled).

Object enable / disable

Regardless of chosen function, for each input the relative ETS page makes available the parameter **Object enable**; the setting allows the activation of object <Input x> Enable Input, 1 bit, which allows enabling of the selected input within the scenario.

KNX PARAMETER	SETTINGS
Object enable	disabled
	enabled
<p>If enabled, this parameter makes available in the ETS page, below it, the items Initial enable state and Enable activation telegram.</p> <p>Initial enable state</p> <p>disabled = after download, initial state is "disabled"</p> <p>enabled = after download, initial state is "enabled"</p> <p>Activation telegram for enable</p> <p>telegram "0" = activation occurs with telegram "0"</p> <p>telegram "0" = activation occurs with telegram "1"</p>	

Communication object "Enable Input" allows to enable/disable the reading or the input.

<Input x> Enable Input	1 bit – Disable/Enable CW
------------------------	-----------------------------

Activation on closing contact

It is used to configure the sending of telegrams when the input is closed; the device can also be configured to send periodic messages with repeat.

In the box **Input name** it is possible to assign a name that will identify the input to the system: for example "input light button". This box is present for all the modes associated with the digital inputs.

KNX PARAMETER	SETTINGS
Contact type	Normally open

	Normally close
It defines how the device will interpret the condition of the digital input.	
Normally open	
The input will be considered active if it is closed.	
Normally close	
The input will be considered active if it is opened.	

For each digital input there is a debouncing function which is used to avoid false switching, ignoring, after the first activation, for a period of time that can be specified in the drop-down menu, **Input reading debouncing time**, between 0 and 1,000 milliseconds.

It is also possible to assign the cyclic (periodic) sending of telegrams to the digital inputs when they are active; as long as the input remains active, the telegram, with size and value selected on the same ETS page, is sent cyclically. The parameter setting defines the time interval between two consecutive submissions. The possible values are subject to the choice of the "short" or "long" option for the setting **Long or short cyclic times**, according to the following table.

KNX PARAMETER	SETTINGS	
	Long or short cyclic times	
	short	long
Cyclic when contact closed/opened	Never	Never
	0.3 s.	30 seconds
	0.4 s.	45 seconds
	0.5 s.	1 minute
	0.8 s.	2 minutes
	1.0 s.	3 minutes
	1.2 s.	4 minutes
	1.5 s.	5 minutes
	2.0 s.	10 minutes
	3.0 s.	15 minutes
	5.0 s.	30 minutes
	8.0 s.	45 minutes

	10 s.	60 minutes
		4 hours
		12 hours
		24 hours

The parameter shown on the ETS page is **Cyclic sending when contact closed** if Type of contact is "normally open" and **Cyclic sending when contact opened** if Type of contact is set as "normally close".

The telegram transmitted as a consequence of the activation of the input, regardless of whether single or cyclic sending is envisaged, is set with the associated Telegram option, according to the following table.

KNX PARAMETER	SETTINGS
Telegram associated	1 bit 1 byte
1 bit	The logic state 0 or 1 is transmitted.
1 byte	1 byte is transmitted containing the value that can be selected from the drop-down menu that appears under this option when it is selected, i.e. : <ul style="list-style-type: none"> • value 0÷255 (unsigned generic int) • value 0÷100% (percentage in steps of 5%) • HVAC mode (DPT_HVACMode 20.102)

Note that for each item in the drop-down menu, the ETS page appears under a new setting which is **Command associated with opening** if the input is set as normally closed and **Command associated with closure** if the input is set as normally open. In all cases, the drop-down menu offers alternatives related to the setting made in the associated Telegram, according to the following table.

KNX PARAMETER	SETTINGS
Command associated with opening	
Command associated with closure	
Value 0÷255	0÷255
Value 0÷100%	0÷100 %
HVAC mode	Auto comfort standby economy protection (antifreeze/high temperatures)

From the ETS page it is possible, with the setting **Command associated with closure**, to define the action that the activation of the corresponding input determines.

KNX PARAMETER	SETTINGS
Command associated with closure/opening	Off on toggle
<p>The parameter is "Command associated with closure" if the input is set as "normally open" and becomes "Command associated with opening" if the input is instead set as "normally close".</p> <p>on Send an activation telegram.</p> <p>off Send a deactivation telegram</p> <p>toggle Send a telegram that orders the inversion of the associated user's state.</p>	

Choosing option toggle, in the ETS page it is possible to set parameter **Feedback object**, as described in the following table.

KNX PARAMETER	SETTINGS
Feedback object	disabled enabled
<p>If enabled, this parameter displays an additional communication object (<Input x> Feedback) which determines the sending, by the actuator receiving the command, of a feedback telegram to check whether the requested operation has been carried out or not. The telegram transmits the state of the actuator.</p>	

Activation on closing/opening contact

It is used to configure the sending of telegrams when the input is active, on both "open" and "closed" conditions and therefore following changes in state.

The parameters are identical to the choice "Activation on closing contact"; "Contact type" is missing and the "Command associated with closure" and "Command associated with opening" settings are simultaneously present because activation will occur following the occurrence of both conditions. For the settings, what has already been explained applies.

The page also makes available the parameter **Feedback object** already explained in "Activation on closing contact" and parameter **Communication object on opening** described as follows.

KNX PARAMETER	SETTINGS
Communication object on opening	disabled enabled
<p>If enabled, this parameter allows to send closure and opening command with two different objects, respectively "<Input x> Closure Action" and "<Input x> Opening Action".</p>	

Activation on short and long contact closure

With this input mode of operation, it is possible to differentiate the actions based on the activation

duration of the input itself. The distinction between "short closure" and "long closure" is defined by the parameter **Minimum time long closure**, according to the following table.

KNX PARAMETER	SETTINGS
Minimum time long closure	0.3 s
	0.4 s
	0.5 s
	0.8 s
	1 s
	1.2 s
	1.5 s
	2 s
	3 s
	5 s
	8 s
10 s	

The time set from the drop-down menu is the time after which the TC57A01KNX device believes that activation is to be considered long.

It is possible to set the sending of telegrams with different values on the short and long print or to decide to send commands only on one of these events.

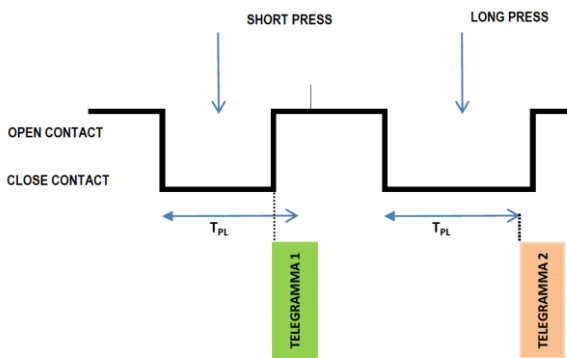

When the input is closed, the time count starts; if the input is opened before the time exceeds the time T_{PL} , the device executes the command associated with the "short closure" event and if, instead, the timeout T_{PL} expires and the input is still being closed, the command associated with the "long closure" event is executed.

The parameters and transmission modes of the telegrams that can be managed through the

"Command associated with short closure" and "Command associated with long closure" settings are the same as those relating to the "activation on closing/opening contact" configuration except for the cyclical send function, which is not foreseen here.

Dimming

With this mode of operation of the inputs it is possible to control adjustment of the light through a dimmer module using the short and long press of buttons connected to the input itself.

Each button uses 2 communication objects:

- 1-bit objects for ON/OFF commands associated with short pressing.
- 4-bit objects for brightness adjustment associated with long pressing.

The "Minimum time long closure" parameter is the same as explained for "Activation on short and long contact closure" and for it and for the setting "Feedback object" what has already been explained applies. Two further settings are available on the page. According to the table, set the minimum duration of the prolonged pressing. "Dimming mode" and "Dimming step" define the behaviour associated with the prolonged pressing.

KNX PARAMETER	SETTINGS
Dimming mode	brighter
	darker
	brighter/darker
brighter	Each time the input is activated, the dimmer controls the increase in brightness according to the setting of Dimming step .
darker	Each time the input is activated, the dimmer controls the decrease in brightness according to the setting of Dimming step .
brighter/darker	Each time the input is activated, the dimmer reverses the progression of brightness by one step or in full according

to the parameter setting **Dimming step**.

Dimming step	Minimum/maximum brightness 1/2 brighter/darker ÷ 1/64 brighter/darker
Minimum/maximum brightness	
It sets the progressive adjustment from minimum to maximum and vice-versa depending on whether "Dimming mode" is "brighter" or "darker".	
1/2 brighter/darker ÷ 1/64 brighter/darker	
It sets the precision of the variation, which will occur depending on whether "Dimming mode" is "brighter" or "darker".	

- 1-bit STEP/STOP objects associated with short pressing;
- 1-bit UP/DOWN objects associated with long pressing.

For the settings common to all the other input operating modes, what has already been explained applies. The following table applies to the Command drive shutter parameter.

KNX PARAMETER	SETTINGS
Command drive shutter	move up move down move up/move down
It defines the movement direction of the roller shutter associated with the prolonged closing of the input.	
move up	
Each time the input is activated, the module commands the total opening of the roller shutter.	
move down	
Each time the input is activated, the module commands the roller shutter to close.	
move up/move down	
Each time the input is activated, the module moves the roller shutter in the direction preceding the one performed following the last activation: if the previous closing of the input raised the roller shutter, further activation will lower it and vice-versa.	

Example 1: Set the dimmer control so that when the button is pressed the brightness gradually goes from minimum to maximum.	
PARAMETER	VALUE
Dimming mode	brighter
Dimming step	Minimum/maximum brightness

Example 2: Set the dimmer control so that when the button is pressed, the brightness increases by 1/4.	
PARAMETER	VALUE
Dimming mode	brighter
Dimming step	1/4 brighter/darker

Shutters and Blinds

Through this function it is possible to control motorised roller shutters using the short and long press of the buttons. Each input uses 2 communication objects:

Scene

In this configuration page it is possible to set the button for the management of the scenarios: storage and execution of the scenarios. These two behaviours (storage and execution) are performed through two different actions: short closing and long closing of the input.

Saving by long closing can be enabled through the parameter **Minimum time long closure** and the related drop-down menu common to the other modes that is used to set the minimum activation

duration of the input to be considered as long closure (activation).
 The following table applies to the scenario settings.

KNX PARAMETER	SETTINGS
Scene number	1 ÷ 64
<p>This parameter sets the value of the scene to be stored/executed (one per channel).</p> <p>As the output devices (i.e. the actuators, etc.) can generally manage different scenes, each identified by a value (which varies from 0 to 63) it is crucial to set this parameter correctly so that it corresponds to the number set on the actuators.</p>	
Store scene on long closure	disabled/enabled
<p>If disabled, the long closure is ignored and no telegram is sent on the bus; if enabled, when long closure occurs, a scene storage telegram is sent on the bus.</p>	
Object enable scene learning from bus	disabled/enabled
<p>If this parameter is enabled, there is a communication object (size = 1 bit) in order to enable/disable runtime from bus the sending of the "learn scene telegram". When this object receives a telegram "1", the function associated with the long closure of the input (sending of telegram for scenario storage) is enabled, while when it receives a telegram "0" with prolonged closing no command is sent.</p>	

Commands Sequences

This function is used to associate sequences of different commands on the bus.
 For each input, this function can be associated with the combination "short and long closure" or with the "toggle" function.
 The sequence consists of 3 commands (A-B-C) which can each be sized as 1 bit or 1 byte. Once the size (1 bit/1 byte) of elements in the sequence has been defined, it is possible to associate different values to each element of the sequence or to decide to send commands only on one of the two events. The waiting time between one command and the next is defined through parameter **Delay between commands**.

Each communication object can be linked to a different group address.
 For example, it is possible to define a sequence as proposed in the following table.

object	dimension	short closure (switching 1)	long closure (switching 2)
A	1 bit	ON (towards actuators)	OFF (towards actuators)
B	1 byte	100% (towards dimmer)	0% (towards dimmer)
C	1 byte	COMFORT (towards thermostats)	ECONOMY (towards thermostats)

Command Sequences (1 bit)

This function is used to send 1-bit command sequences on multiple objects. The sequence can be defined on 2 or 3 objects. Each time the button connected to the input is pressed, the next step of the defined sequence is sent.

KNX PARAMETER	SETTINGS
Number of objects	2, 3
<p>This parameter sets and defines the number of 1-bit objects that will be visible and that will send the values 0 or 1 on the bus</p>	
Number of steps in the sequence	2 ÷ 4 for 2 objects 2 ÷ 8 for 3 objects
<p>It indicates the number of steps that compose the sequence.</p>	
Long closure to restart sequence	disabled/enabled
<p>It is used to associate the restart of the sequence at step zero with the long closure of the input</p>	

Restart function	Restart and send first Send long step and restart
Restart and send first The long press determines the sending of step 1 Send long step and restart The long press causes the next step to be sent and brings the sequence to the initial step.	
Value step long	<Different combinations of values of objects a, b, c>
It defines what happens when a long press is performed (it depends on the "Restart function" parameter)	
Send only changed objects	disabled/enabled
This parameter defines whether, in the passage from one step to the next, all the values associated with one-bit objects must always be sent or only those that change.	
Value step <x>	Combinations of on and off on 2 or 3 1-bit objects
It determines the combination associated with a step in the sequence using 2 or 3 1-bit objects.	

Set RGB colour

This function is used to briefly press the button connected to the corresponding input with a command on the bus to set an RGB colour through an RGB driver for LED lighting. The "RGB object type" parameter defines whether the command is sent with a single 3-byte object or with 3 1-byte objects. It is also possible to enable a function associated with the long press that is used to change the colour associated with the short press. During the long press, a colour transition takes place which is sent on the bus and upon release the selected colour is stored; this means that from now on, every time a short press is performed, the new colour is sent on the bus. When the device is turned off, the last selected colour is kept in memory. The "Enable colour sending during transition" option is used to send all colour transitions during a long

press so that each colour can be viewed on another device.

MUR/DND

This function is used to configure an input to send 1-bit commands with DND (do not disturb), MUR (make up room) or to restore both base signals. The action is set through the drop-down menu **Associated command** which is made available on the ETS page.

The choice of the "Associated command" parameter ("cmd" column of the following table) defines which values are sent on the 2 1-bit objects.

cmd	Action	DND	MUR	Note
MUR	enable	0	1	Obj. MUR send "1" Obj. DND send "0"
MUR	disab.	-	0	Obj. MUR send "0"
MUR	toggle	MUR enab./disab. In sequence		
DND	enable	1	0	Obj. MUR send "0" Obj. DND send "1"
DND	disab.	0	-	Obj. DND send "0"
DND	toggle	DND enab./disab. In sequence		
Loop		0	1	Loop in sequence between these 3 sets of values.
		1	0	
		0	0	

The setting **Reset all** (default) sends a reset command to the related actuators.

The parameter is also available on the ETS page **Additional object** which is used to associate a colour to each of the 3 states (active DND, active MUR, inactive MUR and DND); this colour is sent on the bus using a 3Byte DPT 232.600 RGB value 3x object (0.. 255) and will be reproduced by RGB lighting bodies associated with the TC57A01KNX device.

The following table summarises the parameter setting.

KNX PARAMETER	SETTINGS
Additional object	None RGB
<p>None does not activate any additional objects while clicking on RGB the setting appears on the page Colour associated with... in whose box it is possible to write the hexadecimal equivalent of the colour to be associated with the action for which the additional object has been enabled (MUR, DND, loop) or to select the colour from the palette that appears by clicking on the button with the four coloured squares. The setting Colour associated with "reset all" is also made available where, in the same way as those just described, the colour of the light displayed following the reset command is set.</p>	

Values in loop

With this function it is possible to configure an input to send a 1-byte value in sequence. The sequence consists of a number of values between 3 and 9. Each time the input is activated (according to the "active front" setting), a value is sent following the order set in ETS: from the first (A) to the last (I). The number of values sent depends on the setting of the "Number of elements (values)" parameter. The following two items are made available for this mode.

<Input x> Loop Value Output	1 byte – 0..255 CRT
This object is dedicated to sending the step-by-step sequence.	
<Input x> Loop Value Feedback	1 byte – 0..255 CW
This object is made to receive a value from the bus; if it corresponds to a value set in the sequence, it takes it to the corresponding step.	

11. Analog input for NTC

If on the ETS **General Parameters** page the "analog" option to **Input Type 1** or **Input Type 2** or both is set, the corresponding input or both will become analog and the **Digital inputs** page will appear:

- instead of **Input 1**, the item (and relative ETS page) **Additional probe 1**;

- instead of **Input 2**, the item (and relative ETS page) **Additional probe 2**.

If Input 1 and/or Input 2 are set as analog, they can be associated with the temperature 1 and 2 function, but they are independent from them; the temperature 1 and 2 functions can also not be associated with analog inputs 1 and 2, because these are also independent.

If the temperature 1 function is enabled as a thermostat and the input 1 as analog, it will be input 1 that provides the measurement to the algorithm enabled for the temperature 1 function. Otherwise, the "temperature probe" or "thermostat" algorithms must receive the temperature from the bus.

For each input set as analog, the parameter is available on the General Parameters page **Temperature alarm object** which can be set enabled or disabled.

KNX PARAMETER	SETTINGS
Temperature alarm object 1	enabled disabled
Enabled, it activates the group object "<Temperature 1> Alarm" for the management of events related to the temperature thresholds associated with analog input 1.	
Temperature alarm object 2	enabled disabled
Enabled, it activates the group object "<Temperature 2> Alarm" for the management of events related to the temperature thresholds associated with analog input 2.	

Regarding the temperature functions, when available on the ETS General Parameters page, they provide the following settings from the drop-down menu.

- temperature function disabled** (default);
- temperature sensor**, which corresponds to the use of the probe connected to the input as an input element to be used to detect the temperature and to transmit it on the bus;
- thermostat**, which assigns the probe to the thermostat management implemented by the Fan coil control module with internal or external connections.

Mode 2 and 3 make the item **Temperature 1 function** appear in the menu on the left of the page for Input 1 and **Temperature 2 function** for Input 2. The temperature functions that can be displayed on

the respective ETS pages and respective menus depend on the mode chosen, according to the following table.

KNX PARAMETER	SETTINGS
Temperature function x	Temperature sensor Thermostat
<p>Temperature sensor With this mode, the menu "Temperature x function" appears with its items and respective ETS pages "Reference temperature x" and "Temperature Sensor x". For setting of the parameters of these pages see the section Temperature Sensor in this manual.</p> <p>Thermostat In this mode, the items and respective ETS pages appear in the menu "Digital inputs > Additional probe 1 > Temperature 1 function":</p> <ul style="list-style-type: none"> • Reference temperature 1; • Thermostat settings; • Heat/cool. HVAC setpoint Manual; • Setpoint variation; • Fan Coil - ON/OFF Control. <p>For setting of the parameters of these pages see the appropriate table.</p>	

If the option is selected on the ETS General Parameters page **Use device as fan-coil with internal connections**, the Temperature 1 Function drop-down menu disappears although the relative menu item on the left and the corresponding ETS page remain. Nothing changes, however, for the Temperature 2 Function, which is always independent.

KNX PARAMETER	SETTINGS
Use device as fan-coil with internal connections	no yes
<p>no With this setting it is possible to define the modes for both "temperature 1 and 2 functions" temperature probe and thermostat.</p>	

yes
 With this setting it is possible to choose the modes **temperature probe** and **thermostat** only for the Temperature 2 Function, or to disable it from the corresponding drop-down menu. Temperature 1 function is automatically activated and assigned to Thermostat mode, without the possibility of choosing others (the drop-down menu is not available).

This behaviour stems from the fact that if **Use device as fan-coil with internal connections** is set, the thermostat module associated with the Temperature 1 Function is reserved for the "internal" Fan coil management.

12. Additional probe

For inputs IN1 and IN2, when configured as analog inputs for temperature probe, the eelectron code NTC probes must be used:

- TS01A01ACC (from -20°C to +100°C)
 - TS01B01ACC (from -50°C to +60°C).
- Maximum length of connection cables: ≤ 20 m (braided cable).

TS01A01ACC

Dimensions in millimetres
 NTC resistance tolerance: ± 3%
 Measurement range: -20°C ÷ +100°C
 Cable: 2 wire single insulation
 Cable colour: Black
 Probe colour: Black

ATTENTION:
 Always keep a distance of at least 6 mm from live parts

TS01B01ACC	
D1 = 9 mm D2 = 4 mm L2 = 49 mm L1 = 1250 mm NTC resistance tolerance: ± 2% Measurement range -50°C ÷ +60°C Cable: 2 wire double insulation Cable colour: White Probe colour: White	
ATTENTION: Always keep a distance of at least 3 mm from live parts	

Additional probe is activated regardless of the selection made in the analog input menu.

Additional probe – parameters

All the settings are available on the ETS “Additional Probe x” page, the first of which is **Probe code**, which corresponds to a drop-down menu from which to choose the type of NTC temperature probe connected to the corresponding input; it is necessary to indicate the correct type, otherwise the temperature functions will malfunction, as the TC57A01KNX device has in memory the response curves of the resistance to temperature variations for each NTC and a response is expected based on the type indicated.

The following table applies to the other parameters.

Additional probe – description

When one of the analog inputs is set in “General parameters”, the “additional probe” module is activated, through which it is possible (by connecting the NTC probe) to measure the temperature and to send simple ON/OFF commands when certain thermal events occur. The objects available are the following:

<Additional Probe x> Temperature	1 bit CRT
Send temperature measurement in °C on variation and/or cyclically.	
<Additional Probe x> Upper Threshold	1 bit CRT
Sends On, Off or nothing when the upper threshold set is exceeded in ascent or descent.	
<Additional Probe x> Lower Threshold	1 bit CRT
Sends On, Off or nothing when the lower threshold set is exceeded in ascent or descent.	
<Additional Probe x> Enable Thresholds	1 bit CW
Enables or disables the sending of on/off telegrams.	

KNX PARAMETER	SETTINGS
Activation telegram	Telegram 0 Telegram 1
It defines which telegram value enables the sending of threshold on/off telegrams.	
State after download	Disabled Enabled
It defines whether the sending of threshold on/off telegrams is enabled or disabled after the download.	
Probe adjustment	-4°C, -3°C, -2°C, -1°C, 0°C, +1°C, +2°C, +3°C
It is used to set a temperature offset to correct an impractical reading due, for example, to the location of the probe in a warmer or colder place than the environment to be monitored.	
Hysteresis	0.5°C 1.0°C 2.0°C 5.0°C
It defines the hysteresis value to be applied on the high and low thresholds.	
Upper setpoint value	-20°C ÷ +100°C TS01A01ACC -50°C ÷ +60°C TS01B01ACC
Lower setpoint value	-20°C ÷ +100°C TS01A01ACC -50°C ÷ +60°C TS01B01ACC
Telegram when value is above setpoint	nothing/off/on

It is replicated, in the ETS page, for both the "Upper setpoint value" and "Lower setpoint value" settings; the settings are the same for both.	
Telegram when value is below setpoint	nothing/off/on
It is replicated, in the ETS page, for both the "Upper setpoint value" and "Lower setpoint value" settings; the settings are the same for both.	
Telegram when probe is disabled	nothing off on
It is used to send a telegram on the bus if the associated NTC probe is disabled, for example in order to deactivate a solenoid valve or a heater controlled by an output object of the local or remote device, until the new activation.	
Nothing No telegram is transmitted.	
off It sends an off telegram to the target device, which can be used to turn off probe-related functions.	
on It sends an on telegram to the target device, which can be used to activate probe-related functions.	
Cyclic sending time of telegrams	No of cyclic sending 30 min 1 hour 2 hours
It is replicated, in the ETS page, for both the "Upper setpoint value" and "Lower setpoint value" settings; the settings are the same for both.	
Sending on variation	Never 0.5°C 1°C 1.5°C
It defines whether the device will send telegrams on the bus when the deviation occurs, i.e. the indicated temperature variation.	
Never No sending of telegrams.	
0.5°C ÷1.5°C Deviation value from the current temperature that will determine the sending of telegrams: for example 0.5°C means that if the temperature currently detected is 20°C, the telegram will be sent at 19.5 or 20.5°C.	

Temperature Sensor

The "Temperature Probe" module is similar to the "Additional Probe" module to which it adds a number of communication objects and the possibility of making an average between the measured temperature and an external temperature received from the KNX bus. Remember that the "temperature probe" function is enabled by selecting the menu item in "General parameters > Type of input x analog > Temperature 1 function" **temperature probe**; this selection makes the following objects available.

<Temperature x> Actual Temperature	2 bytes CRT
Send temperature measurement in °C on variation and/or cyclically.	
<Temperature x> KNX Probe Temperature	2 bytes CW
It receives the measurement of another probe via the KNX bus.	
<T.Sensor x> Enable Input	1 bit CW
Enables or disables the sending of on/off telegrams.	
< T.Sensor x> Setpoint Upper	2 bytes CW
It receives the upper setpoint via KNX bus.	
< T.Sensor x> Telegram Upper	1 bit CRT
Sends On, Off or nothing when the upper threshold set is exceeded in ascent or descent.	
< T.Sensor x> Setpoint Lower	2 bytes CW
It receives the lower setpoint via KNX bus.	
< T.Sensor x> Telegram Lower	1 bit CRT
Sends On, Off or nothing when the lower threshold set is exceeded in ascent or descent.	

Probe KNX

On the page **General parameters** when setting the "Temperature function" it is possible to choose "Temperature probe" or "Thermostat"; in both cases the "Reference temperature" page appears. On this page it is possible to enable the reading of a KNX probe that sends measurement data to the thermostat via the communication object.

<Temperature x> KNX Probe Temperature	2 bytes CW
This object is used to receive temperature values from	

other devices.

Enabling takes place from the drop-down menu **Temperature source** found on the page, by choosing the item **KNX probe**. Below is the relative setting.

KNX PARAMETER	SETTINGS
Surveillance time for KNX probe (0=disabled) [min]	0..255 (min)
Whenever the thermostat receives valid data from the KNX probe, it considers this value in the calculation of the measured temperature and resets the internal timeout (monitoring time).	

If the KNX probe is enabled, the monitoring time (Surveillance time) is used to check if the additional temperature sensor periodically sends valid data to the thermostat. This mechanism avoids considering valid some data that may be hours or days old as would be the case if, for example, the additional sensor does not work or the thermostat cannot receive data for a long period of time.



A value must be set for the surveillance time of the additional sensor that is more than double the period set for the cyclical sending of the additional sensor.

13. Input 0-10V/0-20mA

The TC57A01KNX device has two analog inputs, one of which is native (exclusive) which is A4 and one that is promiscuous corresponding to the bidirectional line A3, which can be set as an input at voltage or current level from the drop-down menu on the ETS page General parameters, according to the following table.

KNX PARAMETER	SETTINGS
Analog input/output 3	disabled analog output analog input

Disabled
Line A3 is not being used.

Analog output
A3 works as a 0-10V output exactly like A1 and A2.

Analog input
A3 functions as a voltage or current level analog input like A4.

Input A4 is always available, while A3 is only available if not occupied by the Fan coil management as variable speed fan control. As for A4, the setting is as follows.

KNX PARAMETER	SETTINGS
Analog input 4	Disabled Enabled

In each mode there is an "enable/disable" communication object to enable/disable reading (applies to all) from the input.

<Analog In 3> Value	1 byte unsigned 2 bytes float
This object defines the contained value, for example voltage or percentage.	
<Analog In 4> Value	1 byte unsigned 2 bytes float
This object defines the contained value, for example voltage or percentage.	

By setting "enabled" on the analog input A3, the item and related ETS page are available in the left menu under Analog inputs **Analog input 3**; by setting "enabled" on the A4 analog input, the item and related ETS page are made available in the left menu under Analog inputs **Analog input 4**.

The functions described in the ETS pages of "Analog input A3" and "Analog input 4" are identical and therefore the setting of only one of the inputs will be explained, it being understood that the above will also apply to the setting of the other.

On the ETS page relating to the A3 or A4 analog input, the first box is used to assign a name to the input itself, which can facilitate mnemonically identification in the building. Here are the parameters and their settings.

KNX PARAMETER	SETTINGS
Input	Voltage Current
<p>Voltage</p> <p>Set the input to read the voltage applied to it; in this mode, the item below on the page becomes Voltage and the drop-down menu appears from where it is possible to choose the arc of the measurable voltage, which can be:</p> <ul style="list-style-type: none"> • 0-10 V • 1-10 V • 2-10 V <p>The settings are used to adapt the sensitivity of the input to the voltage range to be measured, meaning it is possible to use the entire measurement range; for example, if the voltage that can occur at the input is between 2 and 10V, it makes no sense to choose 0-10V because, opting for example for the percentage representation 0..100% (see parameter "Type DPT") means that the value contained in the telegram will never drop below 20%. This would affect the resolution of the measurement because it would be carried out at 80% and not in the entire field.</p> <p>Current</p> <p>Set the input to read the current; in this mode, the item below becomes "Current" and two option buttons appear next to it that can be used to choose two measurement ranges:</p> <ul style="list-style-type: none"> • 0-20 mA • 4-20 mA <p>The settings are also used to adapt the sensitivity of the input, as explained for the voltage measurement.</p>	

Inputs A3 and A4 can read a voltage or a current: in the first case it is the 0-10V mode, while in the second the mode is 0-20mA. In voltage measurement, the potential must be positive on the input contact with respect to the module's GND; in the current measurement, the current must enter the input (with respect to GND).

The voltage or current can be generated by a sensor or an external device and inputs A3 and A4 can send the corresponding measurement on the bus, suitably converted into a datapoint suitable for the measurement of the sensor itself (it could be a CO₂ or humidity sensor, a meter of electrical power, current, voltage, etc.).

KNX PARAMETER	SETTINGS
DPT dimension	1 byte unsigned 2 bytes float
<p>1 byte unsigned</p> <p>The value measured by the input is sent on the bus as a single unsigned byte. With this setting, Type DPT offers a drop-down menu with 5.00x options (see table below).</p> <p>2 bytes float</p> <p>The value measured by the input is sent on the bus in the form of two bytes with decimals. With this setting, Type DPT offers a drop-down menu with 9.0xx options (see table after the one below).</p>	

DPT Dimension = 1 byte unsigned	
DPT Type	DPT 5.001 percentage (0..100%) DPT 5.003 angle (degrees) DPT 5.005 percentage (0..255%)
<p>DPT 5.001 percentage (0..100%)</p> <p>The telegram will contain a percentage expression of the measured voltage or current, in relation to the range 0-100%; for example by setting the voltage measurement 0-10 V there will be 0% for 0 V and 100% for 10 V.</p> <p>DPT 5.003 angle (degrees)</p> <p>The telegram will contain the expression in sexagesimal degrees (0÷360°) of the input quantity, therefore, in the case of 0-10 V voltage measurement, 0 V will correspond to 0° and 10 V to 360°.</p> <p>DPT 5.005 percentage (0..255%)</p> <p>The telegram will contain a percentage expression of the reading, but in the range between 0 and 255 % (8 bits).</p>	

DPT Dimension = 2 bytes float	
DPT Type	DPT 9.001 temperature (°C) DPT 9.002 temperature difference (K) DPT 9.004 lux (lux) DPT 9.005 speed (m/s) DPT 9.006 pressure (Pa) DPT 9.007 humidity (RH %) DPT 9.008 parts/million (ppm) DPT 9.009 air flow (m ³ /h) DPT 9.020 voltage (mV) DPT 9.020 current (mA) DPT 9.024 power (kW) DPT 9.025 volume flow (l/h) DPT 9.026 rain amount (l/m ²) DPT 9.027 temperature (°F) DPT 9.028 wind speed (km/h)
<p>The corresponding telegram will contain the current or voltage value that refers to the selected unit of measurement; this setting is used because it is possible to connect various types of sensors and devices that detect a large variety of parameters to the analog input, therefore for a temperature sensor DPT 9.001 or 9.027 would be chosen, for a rain gauge 9.026, for an anemometer 9.028 and so on.</p>	

Based on the setting of the **DPT Dimension** and **DPT Type** parameters, the representation of the **Value for 0%** and **Value for 100%** parameters changes, which means that what follows these parameters changes. The content in square brackets ([]) of the **Send on variation** is also adjusted.

KNX PARAMETER	SETTINGS
1 byte unsigned	
Value for 0% []	0 ... 255
<p>The value in the field can be set between 0 and 255 whatever the choice made with the drop-down menu, with the difference that the following will appear in square brackets:</p> <ul style="list-style-type: none"> Value for 0% [0..100%] for DPT 5.001 percentage (0..100%); 	

<ul style="list-style-type: none"> Value for 0% [degrees] for DPT 5.003 angle (degrees); Value for 0% [0..255%] for DPT 5.005 percentage (0..255%); <p>The entered value is used to indicate what the minimum of the measurement scale corresponds to: setting 0 means zero and entering the highest value means the maximum; in the first case the measurement is valid from the maximum to the minimum, in the second case the opposite is true. The ability to set various values is used to adapt the definition of the measurement to the output of the sensor or device connected to the analog input.</p>	
Value for 100% []	0 ... 255
<p>The above applies, with the difference that in this case the value corresponding to the full scale is specified.</p>	

The meaning of the two parameters now described is as follows: there are sensors or measuring devices that provide a voltage or current that is directly proportional to the physical quantity measured and others that have an inversely proportional voltage or current at the output; for example a temperature sensor with 0-10 V voltage output can deliver 0 V at the minimum measurable temperature and 10 V at the maximum but another can operate in reverse, i.e. it delivers 0 V at maximum temperature and provides an output voltage increasing as the temperature drops, up to 10 V. In the first case, a **Value for 0%** is set lower than the one defined in **Value for 100%**; in the second the opposite is performed.

KNX PARAMETER	SETTINGS
2 bytes float	
Value for 0% []	0 ... 255
<p>The value in the field can be set between -671088 and 670760 whatever the choice made with the drop-down menu, with the difference that the unit of measurement of the quantity will appear in square brackets; for example:</p> <p>Value for 0% [Pa] for DPT 9.006 pressure.</p> <p>The entered value is used to indicate what the minimum of the measurement scale corresponds to: setting 0 means zero and entering the highest value</p>	

means the maximum; in the first case the measurement is valid from the maximum to the minimum, in the second case the opposite is true. The ability to set various values is used to adapt the definition of the measurement to the output of the sensor or device connected to the analog input.

Value for 100% []

0 ... 255

The above applies, with the difference that in this case the value corresponding to the full scale is specified. Also in this case it is possible to enter values between - 671088 and 670760.

It defines the possible periodicity of the cyclic sending of the telegram corresponding to the reading of the corresponding input; setting **No cyclic sending**, telegrams are only sent when there are variations in the voltage or current at the input, the entity of which is defined by the parameter Send on **Send on variation []**. Cyclic sending is a function that is independent of the one on variation, in the sense that the two can coexist.

2 bytes float

Send on variation []

0 .. 670760

It is used to define the minimum deviation of the input quantity when the corresponding telegram is sent; what is explained for the size DPT 1 byte unsigned applies.

KNX PARAMETER	SETTINGS
1 byte unsigned	
Send on variation []	0 ... 255
<p>It is used to define the minimum deviation of the input quantity when the corresponding telegram is sent; it is a sort of hysteresis that is used to avoid the continuous transmission of telegrams following small variations or fictitious variations caused by fluctuations in the output voltage or current of the sensor with the same size detected, or thermal drift or disturbances picked up by the cables connection.</p>	
Cyclic sending time	No cyclic sending 1 minute 2 minutes 5 minutes 10 minutes 15 minutes 30 minutes 45 minutes 1 hour 2 hours 3 hours 4 hours 5 hours 6 hours 8 hours 12 hours

In addition, the input (whether A3 or A4) can use the measurement made as a (logical) input of a control algorithm; this is obtained by enabling the parameter, on the ETS page, **Control algorithm** according to the settings proposed in the following table.

KNX PARAMETER	SETTINGS
Control algorithm	none
	controls
	step
None	It disables the function.
Controls	It enables a controller (in fact there are 2 independent ones) which can be threshold or proportional. With the proportional one it is possible to send a setpoint from the bus and have it to generate a control action (proportional) based on the setpoint value and on the value read. With the threshold controller mode it is possible to establish a value of threshold + hysteresis and an on/off control action when the threshold is exceeded in both directions. The threshold can be varied by bus using the appropriate telegram on the object.
Step	It enables a "step" controller; the reading field is divided into 4 "intervals or steps" based on 4 parameters

entered by the user and, depending on the value read, an on/off telegram is sent when that interval is entered.

Reading of input value and algorithm of control can be enabled through object "<Analog In x> Enable"; use parameters **Enable for input** and **Enable for algorithm** to select the functions subordinate to enable object.

KNX PARAMETER	SETTINGS
Enable telegram	Telegram 0 Telegram 1
It defines which value received on the enable/disable communication object determines enable state.	
Enable state after download	Disabled Enabled
It defines whether the functions are enabled or disabled after the download.	

For both inputs A3 and A4, if enabled at voltage or current level, where the interval set in the drop-down menu **Voltage** or among the options **Current**, starts above zero (1-2 V for the voltage input and 4-20 mA for the current one) an alarm object is made available:

<Analog In 3> Alarm	1 bit: No Alarm/Alarm
This object defines the activation of the alarm in the event of a value less than the minimum of the set interval.	
<Analog In 4> Alarm	1 bit: No Alarm/Alarm
This object defines the activation of the alarm in the event of a value less than the minimum of the set interval.	

For example, if the input is set for voltage reading with a range of 1-10 V and the voltage read is <1 V, 1 is sent on alarm.

This function is used for example to give the alarm in case of interruption of the connection cables with the input.

14. 0-10V outputs

The TC57A01KNX device has two native outputs (A1 and A2) 0-10 V with ground (GND terminal) in common on the terminal block and an additional promiscuous analog output (A3) which becomes available if the parameter is on the ETS page **Analog Input/Output 3** is set as **Output**, i.e. if A3 is not selected as the input.

The A1 and A2 outputs are available and can be used separately when they are not used to manage the Fancoil valves or when the Fancoil is enabled as 2 pipes and therefore only A1 is used, leaving A2 free and configurable as an independent 0-10 V output.

The menu items and respective ETS pages relating to the analog outputs are made available by enabling them from the General Parameters page; to be precise, those relating to A1 and A2 appear if for the parameters **Analog output 1** and/or **Analog output 2** the "enabled" option was selected while for A3 they appear if in the drop-down menu in **Analog 3 input/output** the item **Output** was chosen (table below).

KNX PARAMETER	SETTINGS
Analog output 1	disabled enabled
Qualified enables output A1 which will then provide a voltage value between 0 and 10 V depending on the settings made.	
Analog output 2	disabled enabled
As above, in relation to output A2.	
Analog 3 input/output	disabled analog output analog input
Select analog output to add A3 to the analog outputs.	

For each analog output, the mode chosen from the drop-down menu **Output function** can be set in the specific ETS page (will be explained shortly); the

default is **<Analog Out x> Simple**. Each setting activates a specific object, according to the following table.

<Analog Out x> Command %	1 byte Value 0-100%
<Analog Out x> Discretized Command %	1 byte Value 0-100%
<Analog Out x> Interlock Command %	1 byte Value 0-100%
These three objects are associated with the output set as "simple". The first object defines the contained value, i.e. the voltage in relation to the percentage. The second object approximates the value to the closer value defined by parameters. The third object is used to set the minimum value when a value different from zero is received.	
<Analog Out x> Cool %	1 byte Value 0-100%
<Analog Out x> Heat %	1 byte Value 0-100%
These two objects are associated with the output set as "6-way valve" and define the voltage value corresponding to the percentage contained in the telegram, which determine the opening in cooling or heating.	
<Analog Out x> Increase/Decrease	1 bit Off/On
<Analog Out x> Command %	1 byte Value 0-100%
<Analog Out x> Index	1 byte Value 0-255
These three objects are associated with the "step/index" mode: the first indicates whether the output voltage must increase or decrease at each step; the second indicates at what percentage to set the output; the third (enabled by parameter) indicates a 1 byte value associated to the output value.	
<Analog Out x> Speed 1	1 bit Off/On
<Analog Out x> Speed 2	1 bit Off/On
<Analog Out x> Speed 3	1 bit Off/On

These three 1-bit objects are associated with the "3 speed fan-coil" mode and each set an output voltage corresponding to the speed (they are ON only one at a time).	
<Analog Out x> Interpolation Value	1 byte 2 bytes float
<Analog Out x> Interpolation Value for 0%	1 byte 2 bytes float
<Analog Out x> Interpolation Value for 100%	1 byte 2 bytes float
These objects define the state of the output resulting from the interpolation of value between the two limits set (value for 0% and for 100%); the type of objects is selected through parameters.	

On the ETS page relating to analog outputs, the first box is used to assign a name to the input itself, which can facilitate mnemonically identification in the building. The other parameters and their settings are described below.

KNX PARAMETER	SETTINGS
Output voltage	0-10 V 1-10 V 2-10 V
It sets the range of variation of the output voltage, or establishes the minimum voltage that the output can assume. Based on the chosen setting, the "Voltage x-10 V" item at the bottom of the ETS page and the table next to it change, which for practical purposes suggests how the generated voltage depends on rounded binary values (Value 0-255) or percentages (Value 0-100%) coming from the bus.	
Lock function	disabled enabled
The same applies to the lock function discussed for Relay outputs and shutter control.	
Feedback	disabled enabled
If enabled, it is used to send the state assumed by the	

corresponding analog output to the bus.	
Output is valve	No/yes
<p>By choosing "yes" under this parameter, the following items appear.</p> <p>Global – all valve closed</p> <p>If the "subordinate" option is set, the output responds to the global object <Global All> All Valve closed; the box appears under the item on the ETS page Valve open when output higher than in which it is necessary to write the value (between 0 and 99) in the presence of which, the valve is open. The value in the box, divided by 10, corresponds to the output volts. If Output function is set as valve 6 ways two limits appear to set when the valve is open.</p> <p>Anti-lock function</p> <p>Choosing the "enabled" option, the output controls the valve periodically according to the procedures to be defined on the ETS page accessible from the menu item <Analogic Out x> Anti-lock which is made available when Output function is set as a 6-way valve and in any case if, when present, the item Output is valve is set on Yes.</p>	

The following parameters are available only when **Output function** is set as **simple**.

Limiter function	disabled enabled
<p>It limits the output voltage within a window defined by the minimum and maximum values that can be set in the respective boxes:</p> <ul style="list-style-type: none"> • Truncation approximates values outside the minimum and maximum values; • Linear scales the output voltage set by the bus within the limits defined in the appropriate boxes, then to the difference between Maximum and Minimum (for example if Maximum=155/255 and Minimum=55/255, 0% is 55, 100% is 155 and 50% is equal to 105/255). <p>Using the global object there are two limiters: through the global object is possible to switch between the two configurations.</p>	
H/C logic function	disabled enabled
<p>By responding to the <Global All> Heat/Cool object, based on the settings made in the respective ETS page, it can invert the set interval, force a value (which can be defined in the Value box), decide the state of the logic</p>	

after the download and the type of logic activation telegram.

KNX PARAMETER	SETTINGS
Anti-lock function	disabled enabled
<p>It is used to "move" the solenoid valve to prevent it from becoming encrusted and blocked during long periods of inactivity. If this function is enabled, on the ETS page <Analog Out x> Anti-lock it is possible to set the parameters described here.</p> <p>Movement frequency</p> <p>From the drop-down menu it is possible to select, between 1 and 16 days, with a granularity of 1 day, how long the period of inactivity may last before the valve performs an anti-lock cycle, which consists of an opening and subsequent closing after the time set with the following parameter.</p> <p>Movement time [min]</p> <p>It defines (between 1 and 10 minutes) how long the activation of the valve in the anti-lock function must last.</p> <p>Minimum/maximum value</p> <p>It defines the valve opening excursion through the range of voltage variation at the analog output that will control it.</p>	

Regarding the **Output function**, the relative settings are described in the table below.

KNX PARAMETER	SETTINGS
Output function	simple 6-way valve step/index 3-speed fan-coil interpolation
<p>It sets the analog output to the chosen operating mode, that is, it defines the value that the output assumes in the event of telegrams coming from the bus. Each function makes the specific settings available</p>	

on the ETS page.

Simple

The output goes to the voltage corresponding to the percentage value received by the telegram. The Simple setting includes the "Discretised" variant where the output assumes discrete values established by the parameter. The **simple** outlook can, if set from the relevant ETS page, respond to the interlock.

6-way valve

The 6-way valve is a dual valve circuit commutator that passes hot or cold fluid based on the voltage it reads at the input on a single port. Normally 0 to 3 V is switched to cold fluid, 3 to 7 V is closed and 7 to 10 V is switched to hot. The two objects associated and already described allow mixing of the fluids and assigning intermediate values.

Step/index

The output voltage increases/decreases by a fixed value (step) upon receipt of a 1-bit telegram, the logical value of which determines whether an increase or decrease will occur. From the corresponding ETS page it is possible to set 0..255 steps and up to 5 indices, defining for each a value assumed by the output.

3-speed fan-coil

The output simulates the discrete 3-speed control of the electro-fan of a Fan-coil, i.e. it assumes three values each defined by an object; receiving a speed command on an object, the associated output voltage is set.

Interpolation

A unit of measurement is selected for which, upon receiving an input value, the voltage output is activated proportionally. The parameters set the lower and upper limit of the interpolation interval and, with another specific parameter, these limits can be modified from the bus.

KNX PARAMETER	SETTINGS
Output function	6-way valve
Valves all closed	subordinate non-subordinate

If the "subordinate" option is set, the output responds to the global object **All valves closed**; on the ETS page, two boxes appear under the heading:

- **Valve open when output lower than**
- **Valve open when output higher than**

in which the values (between 0 and 99) must be written in the presence of which, the valve is open in one or the other direction. The value in the box, divided by 10, corresponds to the output volts. The setting is similar to that for the "Simple output function" but there are two voltage values.

For each Output function, in the menu under the item **Analog Out x** the ETS <Analog Out x> output function page becomes available, containing the specific settings. They all have in common the first setting "Output state at power ON".

15. Management of relay outputs

Each relay output can be set to create, alone or in conjunction with others, the possible combinations by defining **functional blocks** described below. The functions can be activated on these outputs if the relays are not occupied by the Fan coil management, for example if the fan is driven by output A3 (3 free relays) or if the fan is not 3-speed (in this case the K2 relays and K3 or only K3 relay are free).

Description of the functional blocks

The relays and outputs can be used singly or in combination to obtain multiple functions; the functional blocks relating to the relays are called K - B - C. The possible functions are shown in the table below.

Block	Number of relays used	Description
K	1	single relay
		electric valve
B	2	shutter (up/down)
		Servomotor (forward/back)
		Interlock 2 outputs (diverter)
C	3	Interlock 3 outputs (commuter)

So in blocks K each relay is managed individually, in B two relays are coupled and in C three relays are combined. All this means being able to create the following combinations of blocks.

Relay 1 ÷ 3 Functional block scheme			
Block	K1	K2	K3
K	K1	K2	K3
B	B1		K3
C	C1		

Blocks K – 1 relay

Each block K identifies the “single relay” functions, i.e. the functions that each relay (K1, K2, K3) can perform individually; they are set on the page **General parameters** (the ETS page **Relay outputs** and the relative submenu will appear differently depending on the function chosen). The possible options are:

- single relay (page Output K1/2/3 Relay ON/OFF);
- electric valve (page Output K1/2/3 Solenoid Valve).

Single relay – General parameters

KNX PARAMETER	SETTINGS
Relay type, normally close or open	normally open normally close

With this parameter it is possible to set the relay operating mode. The relay can be used as "open contact" or "closed contact"; this distinction is only on a logical level because the relay has only one pole (it works as a switch) and there is no terminal connected to the NC contact.

Command (Relay state)	Normally open	Normally closed
ON (activated)	contact closed	contact open
OFF (deactivated)	contact open	contact closed

KNX PARAMETER	SETTINGS
Command activation telegram	Activate with OFF Activate with ON
Determine whether the function is activated with a telegram "1" (therefore off = "0") or with telegram "0" (therefore off = "1")	
Relay state at power on	No action OFF
Relay state at power off	ON
Set this parameter to determine the state that the relay must assume when the bus voltage fails and when it is restored	
Feedback enable/disable	Disabled Always On variation
<p>Disabled: The relay state is never sent.</p> <p>Always The state is transmitted each time the relay receives an actuation command.</p> <p>On variation The state of the relay is only transmitted when its state changes.</p>	
Timing function type	No timing function On/off with timing and delay (stair case) Continuous switching
<p>No timed function No timed function.</p> <p>On/off with timing and delay (stair light) This parameter enables an object dedicated to the management of the timed output [<Output Kx> Timing] with which to set a delay on activation, deactivation or the stair lighting function.</p> <p>Continuous switching The function is activated which switches the relay ON/OFF continuously.</p>	

Single relay – timing on/off

On the ETS page **Relay outputs**, **<Output Kx> Timing** appears under the name of the output set

as **On/off with timing and delay (stair case)**: by clicking on it, the following parameters appear.

KNX PARAMETER	SETTINGS
Timing function activation telegram	Activate on OFF telegram Activate on ON telegram
Set the telegram to activate the timing function	
Timing unit measures	Seconds/minutes/hours
Set the measuring unit for the following timing parameters.	
Switch ON delay (0 = no switch ON delay)	0..255
Set the delay between the receipt of the ON command and the activation of the corresponding output (if set to 0 there will be no delay and execution will be immediate)	
ON state retention time (0 = never switch OFF)	0..255
Set the automatic switch-off time (stair lights); if set=0, switch off must be performed through an OFF command	
Behaviour when receiving deactivation telegram during timing	Ignore command Go to retention end (switch OFF) Go to OFF state after time
Ignore command The OFF command is ignored	
Go to retention end (switch OFF) The OFF command is executed immediately.	
Go to OFF state after time: The off command is executed after the time defined by the parameter Switch OFF delay (0 = switch OFF immediately)	
Switch OFF delay (0 = switch OFF immediately)	0..255
Set the delay between receiving the OFF command and the activation of the corresponding output (by setting 0, execution will be immediate).	

Example 1: Set the stair light to automatically switch off after 5 minutes without the possibility of manual switching off	
PARAMETER	VALUE
Timing unit measures	Minutes
Switch ON delay	0
ON state retention time	5
Behaviour when receiving deactivation telegram receiving during timing	Ignore command

Example 2: Set the stair light to automatically switch off after 50 seconds with the possibility of manual switching off	
PARAMETER	VALUE
Timing unit measures	Seconds
Switch ON delay	0
ON state retention time	50
Behaviour when receiving deactivation telegram receiving during timing	Go to retention end (switch OFF)

Example 3: Set the light to be switched on with a delay of 5 seconds on switching on and 60 seconds on switching off	
PARAMETER	VALUE
Timing unit measures	Seconds
Switch ON delay	5
ON state retention time	0
Behaviour when receiving deactivation telegram receiving during timing	Go to OFF state after time
Switch OFF delay	60

KNX PARAMETER	SETTINGS
Behaviour when receiving activation telegram during timing	Ignore Restart ON state retention timer Extend time
It sets the behaviour of the device when an ON	

command is received while the timing is running.

Ignore

The receiving of an ON command is ignored and the timing continues.

Restart ON state retention timer

Upon receipt of an ON command, the device restarts the timing.

Extend time

Upon receiving of an ON command, the device extends the timing.

Warning signal before switch OFF	Do not signal
	15 seconds
	30 seconds
	1 minute
	2 minutes
	5% of the retention time
	10% of the retention time
15% of the retention time	

It is used to set the pre-warning time before the end of the timed function; the device signals the imminent end of the timing with a short shutdown of the load.

Do not signal:

It does not perform any signal.

15 s/30 s/1 min/2 min

Indicates how long before the end of the timing the pre-warning takes place

5%/10%/15% of the retention time

It indicates how much time before the end of the timing as a percentage the pre-warning takes place (if the timing is 60 seconds, by setting **10% timing duration** the notice occurs 6 seconds before the end).

Command during timing behaviour	Actuate command and reset the timing function
	Ignore command

It determines the behaviour in case of receipt of an ON or OFF command on the command object during the execution of the timing.

Actuate command and reset the timing function

It executes the command received and cancels the timing in progress.

Ignore command

It ignores the command received.

Timing behaviour at power ON	Do nothing
	Restore the timing state

	before power off
It determines the behaviour when the module is switched on.	
Do nothing The timing will only start on command and any timing interrupted by the shutdown will be cancelled.	
Restore the timing state before power off: Restarts the timing interrupted by shutdown.	

Single relay – continuous switching

On the ETS page **Relay outputs** under the name of the output **Continuous switching** appears **<Output Kx> Timing**: clicking on it displays the following parameters.

KNX PARAMETER	SETTINGS
Timing function activation telegram	Activate on OFF telegram
	Activate on ON telegram
Set the telegram to activate the timing function	
Timing unit measures	Seconds/minutes/hours
Set the measuring unit for the following timing parameters.	
Continuous switching ON time	1..255
Relay ON time during continuous switching	
Continuous switching OFF time	1..255
Relay OFF time during continuous switching	

For the parameters **Command during timing behaviour** and **Timing behaviour at power ON**, what has already been explained in the section **Single relay – timing on/off** applies.

Single relay – scene

By enabling the scenario management, it is possible to associate up to 12 KNX scenarios and up to 64 dynamic scenarios to each output (see “Single dynamic scenario relay”).

2 commands can be sent to the scenario object:

- **Recall scenario:** starts the execution of a specific scenario;
- **Save scenario:** saves the state that the relays have when the command is received, so that it is reproduced when the "Recall scenario" telegram is received.

KNX PARAMETER	SETTINGS
Scene sources	Do not use scene objects Enable local scene object Enable global scene object Enable local and global scene objects
Do not use scene objects: The scenarios are disabled for this output Enable local scene object: For this output the scenarios are enabled and are called up via CO <Output Kx> Scene Enable global scene object: For this output the scenarios are enabled and are recalled via global CO <Global All> Scene (see para.:17Global objects) Enable local and global scene objects: For this output the scenarios are enabled both with local CO and global CO.	

By enabling a scenario object, on the ETS page **Relay outputs** appears under the name of the corresponding output **<Output Kx> Scene**: clicking on it the following parameters appear.

KNX PARAMETER	SETTINGS
Enable scene learning	disabled/enabled
If disabled, the output will not be able to execute "Save scenario" commands	
Enable dynamic scene learning	disabled/enabled
See paragraph: Relay single – dynamic scene	
Keep or overrides scene values after download	override/keep
It determines whether on download the scenarios stored with the "save scenario" commands are returned to the value defined in the ETS or not.	

Scene counter	1..12
It defines how many KNX scenarios are associated with the output	
Scene x index	1..64
It defines which index is associated with scenario x	
Scene x value	OFF/ON
It defines whether the state associated with scenario x is ON or OFF after the first download. For subsequent downloads check how the "Keep or overwrite scenarios after download" parameter is set	

Relay single – dynamic scene

The dynamic scene function is compatible with the standard KNX scene and the actuators can use them both at the same time.

The dynamic scene function uses the same 1 byte communication object (DPT 18.001) of the standard KNX scenario, maintaining the same structure and the same meaning.

To activate the dynamic scene function, the "Global Dynamic Scene" parameter on the "Global Objects" page must be set as "enabled"; in this way the <Global All> Dyn Scene object is visible. This 1-bit communication object, one for each actuator, is used to enable/disable runtime storage of the dynamic scenario on the object **<Output Kx> Scene**.

HOW IT WORKS

When the value of the object **<Global All> Dyn Scene** is 0, the dynamic scenario function is disabled; standard KNX scenarios can be learned and executed as set by ETS parameter.

When the value of the object **<Global All> Dyn Scene** is 1, the dynamic scenario function is enabled; during this condition any command sent to the relay is executed and also saved in the memory. When a learning command is sent on the 1 byte object <Output Kx> Scene, the device saves the new state in memory and associates it with the scenario number just received.

If a learning command is sent on the 1 byte object <Output Kx> Scene without having previously updated the state of the output, the actuators consider this as a command to disconnect this channel from the scenario number "n" and from this moment onwards after receiving a command of *recall scenario* for scenario number "n" the channel does not react.

In this way it is possible to associate up to 64 scenario numbers to each actuator output channel.

When the <Global All> Dyn Scene object returns to 0, the learning of the dynamic scenario is completed.

The operation *recall scenario* works in the same way as the standard KNX scenario.

Single relay – additional functions

From the ETS page **Output Kx Relay ON/OFF** additional functions can be enabled according to the following table.

KNX PARAMETER	SETTINGS
Additional object type	Do not use Use for logic function Use for locking function

LOGIC FUNCTION

This function is used to control the load through the result of a logical operation between two logical inputs: the operation is performed between the logical input and the relay command object. By activating this function, <Output Kx> Logic appears under Output Kx Relay ON/OFF.

LOCK FUNCTION

It blocks the relay in a specific condition that remains until an exit command is sent from the lock; any commands received during the period in which the lockout mode is active is not executed. When this function is activated, <Output Kx> Lock appears under Output Kx Relay ON/OFF.

LOCK and LOGIC are alternative functions, therefore they cannot be activated at the same time.

Single relay – logic function

By enabling the logical operation, the outgoing command is the result of a logical operation between the communication object "<Output Kx> Logic" and the object "<Output Kx> Command".

Through ETS it is possible to select the logical operation: each time a telegram is received on the logical object or on the command object, the logical operation is recalculated and the result interpreted as a command for the relay.

The <Output Kx> Logic page offers the following settings.

KNX PARAMETER	SETTINGS
Additional command activation telegram	Active with OFF Active with ON
Used to select the state relating to the activation telegram.	
Additional command logic value after download	Start in OFF state Start in ON state
This parameter is used to select the initial value of the logical operator.	
Logical function for "command" and "additional"	AND NAND OR NOR XOR XNOR
This parameter is used to select which logical operator to use.	
Delay logic output [s]	no delay,1..7
This parameter inserts a delay between the recalculation of the resulting logic function (which occurs after updating the object "<Output Kx> Logic" or the object "<Output Kx> Command" and updating of the state of the relay. The insertion of a delay is used to "filter" overly frequent updates on the state of the outputs due to the recalculation of the resulting logic. The delay is expressed in seconds.	

Single relay – lock function

When the lock function is enabled, it allows, by means of a telegram from the bus, switching of the relay into a defined state and forcing of it to maintain this state even if it receives commands from the bus directed to other switching objects.

KNX PARAMETER	SETTINGS
Lock sources	Do not use lock objects [1] Enable global lock object [1] Enable local lock object. [2] Enable local and global lock objects [2]
[1]: visible if additional object is not set as lock [2]: visible if additional object set as lock	
This parameter refers to the management of lock objects.	
Do not use lock object	The lock function is not used.

Enable local lock object

The lock function is activated/deactivated only through the object <Output Kx> Lock.

Enable global lock object

The lock function is only enabled/disabled through the <Global All> Lock object

Enable local and global lock objects

The lock function is enabled/disabled through the object <Output Kx> Lock or the <Global All> Lock object

On the page <Output Kx> Lock it is possible to set the following parameters.

KNX PARAMETER	SETTINGS
Lock state after download	Unlocked
	Locked
It sets the value of the lock function after the download	
Telegram for lock activation	Activate lock on OFF telegram
	Activate lock on ON telegram
It defines with which telegram to lock and with which to unlock.	
Automatic unlocking time (0 = never automatically unlock) [min]	0..255
The lock can be set as a time function, at the end of the lock time the lock function is disabled.	
If the lock function is set with automatic deactivation, the timeout time is reloaded each time a new lock telegram is received.	
Output value when locked	Switch OFF
	Switch ON
This parameter selects the state that the relay must assume when the "lock" function is activated.	
Output value when unlocked	Switch OFF
	Switch ON
	Switch to last value received
	Switch to last value before lock
Switch OFF	
Relay in OFF.	

Switch ON
Relay in ON.

Switch to last value received

The relay returns to the position corresponding to the last command received.

Switch to last value before lock

The relay returns to the position prior to the activation of the lock.

Single relay - Global command object

This parameter refers to the management of global objects (see para. Global objects) and is set according to the following table.

Global command object	Do not use global command object Use global command object as command Use global command object for logic
Do not use global command object	
The result of the logic function is calculated without taking into account the values received on the global object	
Use global command object as command	
The global command is interpreted as a command that overlaps the result of the logical operation.	
Use global command object for logic	
The global command is put into logic with the result of the main logic; the two logical operators can be different. On the page <Output Kx> Glob Obj Logic below the relevant relay, the following settings appear.	
<ul style="list-style-type: none"> Logic for global command in which the functions are available in the drop-down menu AND, NAND, OR, NOR, XOR, XNOR. Delay global logic output [s] from which the drop-down menu can be selected between 0 (no delay) and 7 seconds. 	

Electric valve – general parameters

The 1 relay configuration is also used to manage ON/OFF solenoid valves for heating/cooling systems. The open or closed relay condition must be correctly

associated with the open or closed valve condition as there are valves that are powered and open (NC) and others that are powered are closed (NO). The control of this type of valves can be of the ON/OFF type through the 1 bit object <Output Kx> Open/Close or PWM type. PWM control is used to eliminate the temperature hysteresis typical of the ON/OFF control. The relay operates the valve with the ON/OFF commands but performs a proportional control (0% ÷ 100%) based on the value received on the object <Output Kx> PWM%; the relay performs an open/closed cycle and the duration of the ON and OFF states is modulated on the basis of the PWM% value (see graph).

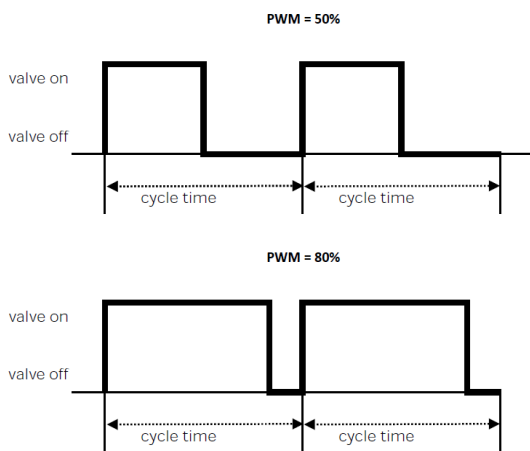

KNX PARAMETER	SETTINGS
Valve position when relay is open	Open Closed
Defines the state of the valve when it is not powered: Open is valid for normally open (NO) solenoid valves and Close is set for normally closed (NC) valves.	
Telegram for valve open	Telegram 0 Telegram 1
Determines the value of the telegram corresponding to an open valve, taking into account "Valve position when relay is open".	
Global all valve closed	Not subordinate Subordinate
Determines whether the output will respond or not to the global object "All Valve Closed".	
Cycle base time for PWM [min] (only for 1 Byte object)	5 .. 255
Set the duration of the relay ON/OFF cycle: the solenoid	

valve will perform an on/off cycle of the same duration. Applies only for 1 Byte object <Output Kx> PWM %

PWM lower limit value	0 % ÷ 30 %
It defines the minimum received value below which the valve is always closed (because powered it would not have time to reopen).	
PWM upper limit value	70 % ÷ 100 %
It defines the maximum received value above which the valve is always open (because it would not have time to close again).	
Feedback state	disabled/enabled
It defines whether or not to send the state with 1-bit object.	
Feedback PWM %	disabled/enabled
It defines whether or not to send the state with 1 byte object	
Anti-lock function	disabled/enabled
It is possible to enable an automatic valve switching function, useful in case of long periods of inactivity, for example for heating during the summer season. If this function is activated, it is possible to select how long the period of inactivity can last (see the parameter "Anti-lock movement frequency") before the valve performs an anti-blocking cycle, which consists of opening and subsequent closing after 5 minutes.	
Anti-lock movement frequency	from 1 time per day up to 1 time every 16 days with 1 day granularity
This setting appears by clicking enabled on Anti-lock Function and determines how often the valve must be powered in the absence of commands.	
Behaviour on power up	None Valve close Valve open
It defines how the valves are to be managed when the voltage returns to the bus after a drop. None Nothing changes in the setting made in the "valve state". Valve close The valve will be brought to the closed state, therefore powered if normally open and not powered if normally closed. Valve open The valve will be brought to the open state, therefore powered if normally closed and not powered if normally open.	
Behaviour on power down	None

	Valve close
	Valve open
It defines how the valves are to be managed in the event of a bus voltage failure. For the three options, the above applies to the previous setting.	

Electric valve – lock function

When the lock function is enabled, it allows, by means of a telegram from the bus, switching of the relay into a defined state and forcing of it to maintain this state even if it receives commands from the bus on other switching objects.

KNX PARAMETER	SETTINGS
Lock sources	Do not use lock objects Enable global lock object Enable local lock object Enable local and global lock objects
This parameter refers to the management of global objects (see para. Global Objects)	
Do not use lock objects The lock function is not used.	
Enable local lock object The lock function is only enabled/disabled through the object <Output Kx> Lock.	
Enable global lock object The lock function is only enabled/disabled through the object <Global All> Lock.	
Enable local and global lock objects The lock function is enabled/disabled through the object <Output Kx> Lock or the object <General All> Lock.	

The specific parameters of the lock function are the same seen for the management of the single relay (see Single relay – lock function).

Block B – 2 relays

Block B identifies the functions that can be achieved by coupling 2 relays (K1 and K2), which are:

- Shutter;
- Servomotor;
- Interlock with 2 relays (see para. Relay with interlockRelay with interlock);

Shutter – general parameters

Relays K1 and K2 can be "combined" to control roller shutters through block B1, according to the functional table:

Block B1 - 2 relays – Roller shutter with 2 limit switches					
B1	K1/2	K1	▲ (UP)	K2	▼ (DOWN)

Selecting **Shutter** from the drop-down menu, the menu item appears on the ETS Relay outputs page **Output B1 Shutter** and the following settings become available.

KNX PARAMETER	SETTINGS
Shutter travel time [s]	0 ÷ 3000
This parameter sets the total running time of the roller shutter.	
Compact time [s]	0 ÷ 255
It sets the activation time to compact the roller shutter in descent.	
Extra time for shutter travel up [s]	1 ÷ 30
This parameter indicates the number of seconds to add to the run time for all movements that bring the roller shutter to "up" position.	
Extra time for shutter travel down [s]	1 ÷ 30
This parameter indicates the number of seconds to add to the run time for all the movements that bring the roller shutter to "down" position.	
Stop time between 2 same shutter movements	From 1 second to 5 seconds
It defines the minimum stop time between two consecutive movements of the roller shutter in the same direction.	
Stop time between 2 opposite shutter movements	From 1 second to 5 seconds
It defines the minimum stop time between two	

consecutive movements of the roller shutter in opposite directions.	
Up/down source	Do not use up/down object Enable up/down object
This parameter refers to the management of the 1-bit up/down object. Do not use up/down object The up/down object is not used Enable up/down object The object <Output B1> Up/Down is activated for up/down command.	
Source % source	Do not use shutter object Enable shutter object
This parameter refers to the management of the 1-byte position % object.	
Feedback up/down	Disabled Enabled
Enable the object <Output B1> Up/Down Status that sends the direction of the last movement on the bus.	
Feedback shutter position %	Disabled Enabled
Enable the object <Output B1> Shutter Status that sends the roller shutter position % on the bus.	
Feedback rising and lowering	Disabled Enabled
Enable the object <Output B1> Rising Status and <Output B1> Lowering Status that send the indication on the bus if the roller shutter is moving up/down respectively (1) or stopped (0).	

Shutter – alarms

The alarm function must be enabled if the roller shutter is controlled by weather sensors (usually rain and wind); activation takes place from the page **Relay Outputs - <Output B1> Shutter** by clicking on the Enabled option, and the object <Output B1> Alarm and the related ETS page appear in the menu.

When the alarm function is activated, the roller shutter performs a defined action and cannot be moved unless the lock function is activated, which has the highest priority.

By activating the alarm function the parameters can be set:

KNX PARAMETER	SETTINGS
Activation telegram	telegram 0 telegram 1
It defines which 1-bit telegram value activates the alarm function for this block.	
Supervision time for alarm (0 = supervision timeout is ignored) [min]	0 ÷ 120 
This parameter selects the duration of the surveillance time for the alarm function. If it is set to 30 min, the roller shutter must receive a telegram from the sensor at least once in 30 minutes, even if the telegram indicates “No alarm”. If this does not happen, the alarm becomes active and the receipt of a “No alarm” telegram will be required to reset. Therefore, the sensor must be set to perform a cyclic sending and it is advisable to set the supervision time greater than double the cyclic sending period. The value 0 means that the roller shutter does not check receiving of the cyclic telegram.	
Shutter action on alarm activation	Stop - no movement Move up Move down
It defines how output B1 should behave in case of alarm activation for this block. Stop - no movement The K1/K2 relays of the block stop/remain at rest. Move up K1 is activated to raise the roller shutter. Move down K2 is activated to lower the roller shutter.	
Roller shutter action - alarm deactivation	None Move up Move down Last value received Last value before alarm
It defines how output B1 should behave when the alarm is deactivated for this block: for the first three modes, what is explained for alarm activation applies, while the last two are described below. Last value received It executes the last command received before deactivating the alarm, then the one possibly caused by the activation of the alarm. Last value before alarm It executes the last command received before the alarm is activated.	

Shutter - automatic movements

The automatic movements of the roller shutters are useful for managing situations related to the presence/absence of persons in the room (detected by presence sensors) or connected to the solar radiation of the windows (detected by an external brightness sensor). The actions in both cases may depend on the state of HVAC active in the building: heating or air conditioning.

Enabling the parameter **Presence/Sun automatic movement** the ETS <Output Bx> Auto Movement page becomes available and the communication objects become active:

<Output B1> Auto Movement	1 bit
< Output B1> Presence/Sun	1 bit

From the Global Objects management page, it is instead possible to enable the object:

<General All> Heat/Cool	1 bit
-------------------------	-------

<Output B1> Auto Movement enables/disables the management of automatic movement; for example, if the roller shutters are required to be in a fixed position during the night, the automation is disabled.

<Output B1> Presence/Sun: indicates to the Roller shutter output block whether there are persons in the room (telegram 1) or not (telegram 0).

If used for the management of solar radiation on building façades, it indicates whether the façade is irradiated (telegram 1) or not irradiated (telegram 0).

<General All> Heat/Cool allows differentiating of the automatic actions on the basis of the current season.

By closing the roller shutters in the summer when the façade of the building is irradiated by the sun, it prevents the rooms from overheating, saving energy spent on air conditioning; in winter it is, instead, preferable to let the sun's rays in to heat the rooms as much as possible.

KNX PARAMETER	SETTINGS
Telegram for automatic movement activation	Activate automatic movement on OFF telegram

	Activate automatic movement on ON telegram
It defines which 1-bit telegram value activates the automatic movement function.	
On Presence/Sun telegram while manual mode	No action Enable automatic movement
It defines the behaviour in manual mode in case of receiving of a telegram relating to the activation of the presence or light sensor.	
No action It ignores the telegram.	
Enable automatic movement It enables automatic movement as set in the ETS page.	
Time deactivation automatic mode (0 = time unlimited)	0 ÷ 12 hours
It defines a possible deactivation period of the automatic movements set in the ETS page, for example because maintenance is required. By setting a time, the item appears below the drop-down menu Action on reactivation , which provides the following options.	
No action At the end of the deactivation time, if an automatic movement has been interrupted and the conditions that triggered it still exist, it cancels the relative command: the roller shutter will only be activated automatically when a subsequent telegram relating to Presence/Sun or manual action.	
Automatic action At the end of the deactivation time, if an automatic movement has been interrupted and the conditions that triggered it still exist, the execution of the related command resumes.	
Shutter in cool mode for command OFF	0 ÷ 100%
It defines the opening percentage of the roller shutter in case of an OFF command in cooling/conditioning mode.	
Shutter in cool mode for command ON	0 ÷ 100 %
It defines the opening percentage of the roller shutter in case of an ON command in cooling/conditioning mode.	
Shutter in heat mode for command OFF	0 ÷ 100 %

It defines the residual opening percentage of the shutter in the event of an OFF command in heating mode.

Shutter in heat mode for command ON	0 ÷ 100 %
--	-----------

It defines the residual opening percentage of the shutter in the event of an ON command in heating mode.

Automatic movements are a function designed for installations where there is a presence sensor in a room that sends ON (presence) and OFF (absence) commands; in this case it is possible to take advantage of these commands to change the opening of the roller shutter automatically, differentiating its behaviour between the season in which the heating is active (cold) and that in which the cooling is active (summer).

Shutter - scene

By enabling the scene management, it is possible to associate each roller block with up to 12 KNX scenarios and up to 64 dynamic scenarios (see:

Shutter - dynamic scene)

The following 2 commands can be sent to the scenario object.

Recall scenario: it is used to start the execution of a certain scenario.

Save scenario: it is used to save the current state of the shutter (when the command is received); this state is reproduced when the "Recall scenario" telegram is received.

KNX PARAMETER	SETTINGS
Scene sources	Do not use scene objects
	Enable local scene object
	Enable global scene object
	Enable local and global scene objects

Do not use scene objects
 The scenarios are disabled for this output.

Enable local scene object
 For this output the scenarios are enabled and are called up

via CO <Output B1> Scene.

Enable global scene object

For this output the scenarios are enabled and are recalled via global CO <Global All> Scene (see para Global objects).

Enable local and global scene objects

For this output the scenarios are enabled with both local CO and global CO.

The <Output B1> Scene page will show the following parameters:

KNX PARAMETER	SETTINGS
Enable scene learning	disabled/enabled
If disabled, the output will not be able to execute "Save scenario" commands.	
Enable dynamic scene learning	disabled/enabled
See paragraph: Shutter - dynamic scene.	
Keep or override scene values after download	override/keep
It determines whether on download the scenarios stored with the "save scenario" commands are returned to the value defined in the ETS or not.	
Scene counter	1..12
It defines how many KNX scenarios are associated with the output	
Scene x index	1..64
It defines which index is associated with scenario x.	
Scene x shutter position	0% .. 100%
It defines the position of the roller shutter associated with scenario x after the first download; for subsequent downloads, check how the "Keep or override scene after download" parameter is set.	

Shutter - dynamic scene

DESCRIPTION

The dynamic scene function is compatible with the standard KNX scene and the actuators can use them both at the same time.

The dynamic scene function uses the same 1 byte communication object (DPT 18.001) of the standard KNX scenario, maintaining the same structure and the same meaning.

To activate the dynamic scenario function, the "Global Dynamic Scene" parameter on the "Global Objects" page must be set as "enabled"; in this way the <Global All> Dynamic Scene object is visible. This 1-bit communication object, one for each actuator, is used to enable/disable runtime storage of the dynamic scenario on the object <Output B1> Scene.

HOW IT WORKS

When the value of the object "<Global All> Dynamic Scene" is 0, the dynamic scenario function is disabled; standard KNX scenarios can be learned and executed as set by ETS parameter.

When the value of the "<Global All> Dynamic Scene" object is 1, the dynamic scenario function is enabled: during this condition any command sent to the relay is executed and also saved in memory. When a learn command is sent on the 1 byte object "<Output B1> Scene" the device saves the position of the roller shutter in its memory and associates it with the scene number just received.

If a learn command is sent on the 1 byte object "<Output B1> Scene" without having previously updated the position of the roller shutter, consider this as a command to "disconnect" this channel to the scenario number "n" and from this moment on after having received a recall scenario command for the scenario number "n" the channel does not react. In this way it is possible to associate up to 64 scene numbers on each actuator output channel. When the object "<General All> Dynamic Scene" returns to 0, the learning of the dynamic scenario is completed.

The operation recall scenario works in the same way as the standard KNX scenario.

Shutter - lock

In the case of roller shutters, the lock function has the same behaviour seen for the relays used as single (K1, K2, K3). The lock function has the highest priority, even on alarms and as long as the roller shutter does not exit the lock state, no movement can be performed.

Servomotors - general parameters

The servomotors control function is set by selecting the item "02: 1x2 relays + 1x1 relay" in the **Relay outputs** drop-down menu of the ETS **General parameters** page and then, by selecting the **Servomotor** item from the drop-down menu relating to **Relay B1** that appears.

The Relay B1 setting activates a block including the association of 2 (K1 and K2) relays for the management, in HVAC systems, of servomotors, 3-way valves or ventilation grilles. Relay K3 works independently.

The management of the 3-way valves is performed using coupled relays: in each pair of relays, one performs the OPENING action and the other the CLOSING action.

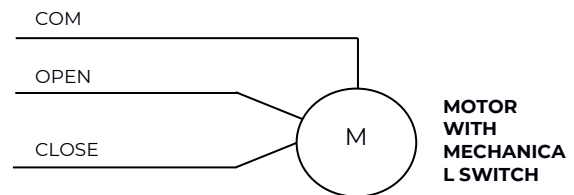

In the ETS page **Relay outputs** the menu item **Output B1 Servomotor** and a series of parameters are made available, in addition to those already described for Blocks B1 (relay outputs) which are used to set:

- the total revolution time;
- the extra time for opening;
- the extra time for closing;
- the minimum pause time between two consecutive movements (same/opposite);
- the frequency of the anti-lock function;
- the states sent on the bus.

Through the corresponding 1-bit communication objects it is possible to set the position of the valve or of the servomotor.

<Output B1> Position 1	1 bit
<Output B1> Position 2	1 bit
<Output B1> Position 3	1 bit

As defined by the parameters in the following table.

KNX PARAMETER	SETTINGS
Position 1	0% ÷ 100% (default 30%)
Position 2	0% ÷ 100% (default 65%)
Position 3	0% ÷ 100% (default 100%)

The other parameters on the ETS page are those shown in the following table.

KNX PARAMETER	SETTINGS
Total revolution time [s]	0 ÷ 3000
This parameter sets the time corresponding to the complete revolution of the servomotor in one direction or the other (duration of activation of the relay corresponding to the movement required by the appropriate command).	
Extra time for motor opening [s]	1 ÷ 30
This parameter indicates the number of seconds to add to the rotation time relating to the complete opening movement.	
Extra time for motor closing [s]	1 ÷ 30
This parameter indicates the number of seconds to add to the rotation time relating to the complete closing movement.	
Stop time between 2 same motor movements	1 ÷ 5 seconds
It defines the minimum stop time between two consecutive rotations of the servomotor in the same direction.	
Stop time between 2 opposite motor movements	1 ÷ 5 seconds
It defines the minimum stop time between two consecutive rotations of the servomotor in opposite directions.	
Telegram for open	Telegram 0 Telegram 1

It determines the telegram value corresponding to the rotation of the servomotor or solenoid valve in the open position.	
Anti-lock function	disabled/enabled
By enabling this function, useful for avoiding the gearmotor locking due to long inactivity, the output activates the relays to ensure that the servomotor is moved completely in one direction and returns to the initial position 5 minutes later.	
Anti-lock movement frequency	from 1 time per day up to 1 time every 16 days with 1 day granularity
Behaviour on power up	Stop - no movement Close Open
It defines the position of the servomotor (or solenoid valve) when voltage returns to the bus after a drop.	
Stop - no movement Nothing changes in the state that existed before the voltage drop.	
Close It rotates in the closed direction.	
Open It rotates in the open direction.	
Feedback state	Disabled Enabled
Enable/Disable the object <Output B1> Status that sends the direction of the last rotation performed on the bus. Setting Enabled , the parameter Telegram value for status sending appears and proposes the following two options	
Telegram 0 is open: the "open" state will be sent with a telegram of value "0".	
Telegram 0 is close: the "close" state will be sent with a telegram of value "0".	
Feedback position %	Disabled Enabled
It enables the object <Output B1> Position Status % that sends the percentage rotation of the servomotor to the bus.	
Feedback opening and closing	Disabled

	Enabled
Enables the object <Output B1> Opening Status and <Output B1> Closing Status that send the indication on the bus if the servomotor is rotating towards opening or closing respectively.	

Block C - 3 relay

Block C identifies the functions obtained by the combination of the 3 relays (K1, K2, K3), i.e. Interlock with 3 relays.

16. Relay with interlock

The INTERLOCK function is used to use a group of (consecutive) relays in interlocked mode, that is, so that only one relay at a time, or no relay can be activated within each group. Interlocking relay groups are usually used to interface other subsystems (alarm, audio, entertainment, etc.) through the dry contact outputs of the relays.

The interlock function is available for the 2 relays K1, K2 or for all 3 relays K1, K2, K3 and can only be enabled if all the relays are not involved in the fan coil function (i.e. if the "Speed type" parameter is selected as "proportional" and then of the "relay outputs" parameter such as "03: 1x3 relay" or "02: 1x2 relay + 1 relay").

The groups of interlocked relays can be those described in the table.

Block B - 2 relays in interlock	
B1	OUT1/2

Block C - 3 relays in interlock	
C1	OUT1/2/3

Main parameters for the management of interlock relays:

KNX PARAMETER	SETTINGS
Contact type	normally open
	normally close
The parameter is unique for the entire group of interlocked	

relays. Choosing "normally close" all the relays in the group will be closed except for the one that is activated which can remain open. Choosing "normally open" all the relays of the group will be open except for the one that is activated which can remain closed.

Contact delay [s]	1 ÷ 16 seconds
It defines the inhibition time between the deactivation of a relay and the activation of another relay.	
Interlock activation telegram	Telegram 0
	Telegram 1
It defines the value of the 1-bit relay activation telegram.	
Lock sources	Do not use lock objects
	Enable local lock object
	Enable global lock object
	Enable local and global lock objects
This parameter refers to the management of lock objects.	
Do not use lock object The lock function is not used.	
Enable local lock object The lock function is activated/deactivated only through the object: <Output B1> Lock for interlock 2 relays <Output C1> Lock for interlock 3 relays	
Enable global lock object The lock function is only enabled/disabled through the <Global All> Lock object	
Enable local and global lock object The lock function is enabled/disabled through the local object or the <Global All> Lock object	
On the page dedicated to the block function for the group of interlocked relays, it is possible to establish the behaviour of the group in case of activation and deactivation of the block, after the download, etc.	
Feedback state	Disabled
	Enabled
Enable/Disable the object <Output B/C1> Status X (2 objects for block B, 3 objects for block C) that indicate the activated relay. Setting enabled , the parameter Telegram value for status sending appears and proposes the following two options: Telegram 0 is open: the "open" state will be sent with a	

telegram of value "0".

Telegram 0 is close: the "close" state will be sent with a telegram of value "0".

Communication objects.

<Output B/C1> Command x	1 bit – On/Off CW
Use these 1-bit commands to activate/deactivate the individual relay outputs.	
<Output B/C1> Status x	1 bit – On/Off CRT
Objects for sending the relay output states	
<Output B/C1> Command Value	1 Byte – 0-255 CW
Use this 1-byte command to set the index of the relay to be activated: 1 = active first relay of the interlock group, 2 = active second relay of the interlock group, 0 = all relays of the group deactivated.	
<Output B/C1> Value Status	1 Byte – 0-255 CRT
Object for sending the state of the group of interlocked outputs: 1 = first relay of the interlock group is active, 2 = second relay of the interlock group is active, 0 = all the relays of the group are deactivated.	
<Output B/C1> Lock	1 bit – On/Off CW
Object used to activate local lock.	

17. Global objects

The following communication objects are available for global functions:

OBJECTS RELATING TO ALL OUTPUTS	
<Global All> All Valve Closed	1 bit – On/Off CRT
It is an object connected to the outputs that manage the valves, i.e. the blocks: Solenoid valve Servomotor	

Fan-coil	
Each time a block of the type listed above is configured, it can be subordinated to the "All valve closed" function This object considers the state of the valves and sends the value 1 if at least one valve is open and the value 0 if they are all closed. It is possible to give consent to a delivery pump that feeds the hydraulic circuit.	
<Global All> External Valve Closed	1 bit – On/Off CW
The "all valve closed" function can also consider the valve states on other devices. It is enough to connect the "<Global All> All Valve Closed " output object of the other device to the "<Global All> External Valve Closed " communication object, in this way it is possible to connect "in cascade" more than two devices in order to have the information "all valves are closed or not" on the last communication object output and consequently drive the hydraulic pump correctly. The input object can be enabled for a read request on power on to have a correct alignment of the data after a power down.	
<Global All> Lock	1 bit – On/Off CW
This object can be used to manage the lock function for multiple outputs, then subordinating the different blocks to this global function	
<Global All > Scene	1 Byte – 0-255 CW
Object used to manage scenarios for multiple outputs, then subordinating the various blocks to this global function	
<Global All > Dyn Scen	1 bit – En/Dis CW
Object used to enable/disable dynamic scenarios	
<Global All> Heat/Cool	1 bit – H/C CW
Object used to communicate the state of the HVAC system to the actuator to manage automatic behaviour on roller shutters or valves and fan coil speeds.	

OBJECTS RELATING TO SINGLE RELAY OUTPUTS	
<Global Single> Command	1 bit – On/Off CW
Object used to manage global On/Off commands on single relays; in the parameters it is possible to associate the telegram received on this object for the logic function (if enabled) or as command.	

OBJECTS RELATING TO THE ANALOG OUTPUTS A1,2,3	
<Global Analog Out> Limiter	1 bit – On/Off CW
<p>Object used in the analog outputs in independent mode (Use device as fancoil with internal links = no) with analog outputs set to perform the "simple" function (Output function = simple). Upon receipt of the values "0" and "1" on this object, the output adopts limiter 1 or limiter 2 depending on the parameters set.</p>	

18. Logics

For a description of the logics present and how to use them, consult the Application Note on the website called "Logic Functions"

19. Virtual holder (automatic presence function)

For a description of the "Virtual Holder" function and its methods of use, consult the Application Note on the website called "For a description of the logic present and how to use it, consult the Application Note called "Virtual Holder" on the site